

Index	3
Advantages of GMN high frequency spindles	
The development	4
Advantages of hybrid ceramic bearings	5
Design	
Bearing systems, Lubrication system	6 - 7
Coolant through the shaft	8
Utility connections	9 - 11
Typical installation schematic	12
Spindle selection - Standard and Options	13 - 15
Technical data	16 - 21
Motor	
Description	22
Power characteristics	23 - 36
Drives	
Drive systems, Tachometer	37 - 39
Accessories - Cable	40
Tool interface	
Safety aspects	41
Spindle nose and Grinding quill interface, Speed limitation	42 - 45
Shrink fit tool holders	46 - 47
Short taper interface	48
HSK style interface, Clamping system	49 - 50
Tool clamping systems	51
Accessories	
Oil/air lubricator, Chillers	52 - 55
Proper spindle selection	
Applications	56 - 59
Workpiece cooling	60
Quality assurance	61
Successful specific spindles	62

The Development

Increase of power and torque

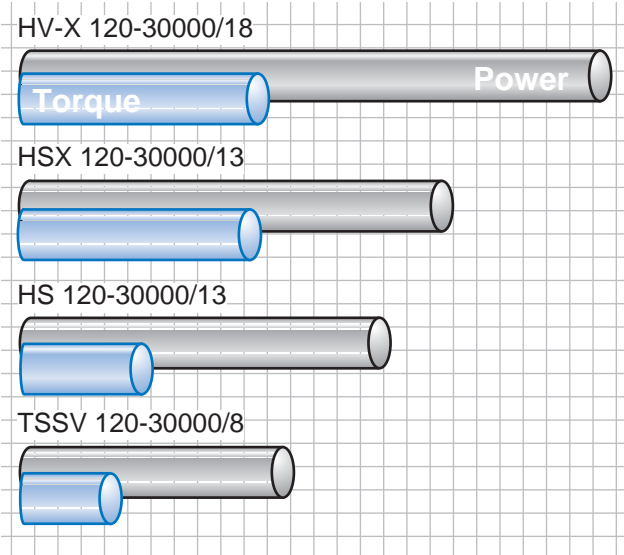

Improvement of the axial and radial stiffness

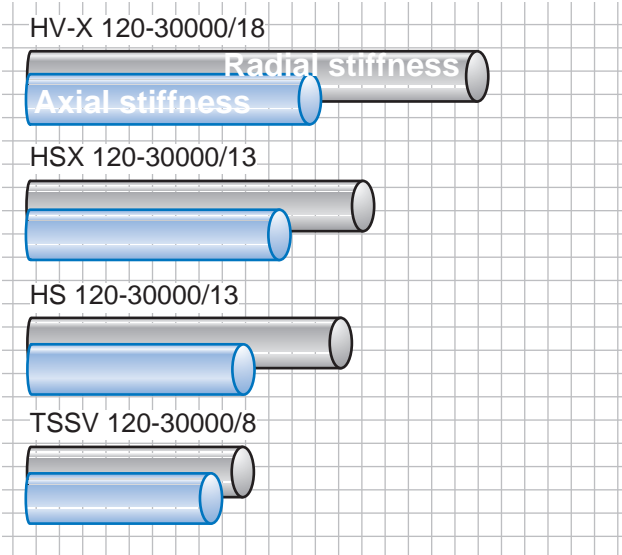

Power, torque and stiffness have been constantly increased as the tables indicate. In addition, reliability, load carrying capacity and working life were also improved. The working life of HSX-spindles in comparison to the HS-spindles is on average 3 times longer.

Economical

With the improvements of power, load carrying capacity and stiffness in the **HV-X** designs the working range of single spindles is extended over the previous models. These enhancements minimize the number of spindles required to cover a large speed range. The special motor design also permits the use of more economically sized frequency converters to match the application requirements.

Selection

The GMN product line covers a vast range of speeds, output powers, load capacities and options to meet or exceed all application requirements.

Tradition

GMN strives to provide its customers with the latest advances and technology in spindle design and concepts. With our **"Customer First" mentality** we will continue to manufacture our traditional style spindles, components and provide service and support for the older models and designs.

Advantages Of Hybrid Ceramic Bearings

GMN high frequency spindles utilize hybrid ceramic ball bearings. These bearings have standard steel bearing races and are matched with silicon nitride balls. Advantages of hybrid bearings compared with normal spindle bearings are:

Reduced wear

The high degree of hardness of the balls, and the nongalling effect of the silicon nitride against metallic material lessens the wear. This is especially important in cases of minimal lubrication. In addition, wear particles will not embed themselves into the balls to further damage the races.

Rigidity

Modulus of elasticity is greater than steel, which increases the static and dynamic stiffness. The increase in dynamic rigidity depends on the ratio of bearing preload to the centrifugal force on the balls.

Friction

Because of the reduced spin-rolls ratios and lower Hertzian stresses, friction and respectively operating temperatures are reduced.

Axial shaft movement

As a result of the lightweight ceramic balls, centrifugal forces are reduced with a corresponding reduction in dynamic movement of bearing races. In addition, movements due to less friction and the lower coefficient of expansion of ceramics are reduced.

Reliability of operation

The low thermal coefficient of expansion of the ceramic balls lessens the reduction of the radial running fits in the bearings. These fits are less variable at higher temperature differentials between races.

Vibrations

Radial forces and the moments acting on the bearings produce displacement between the balls and the retainer. Hybrid bearings reduce this effect and produce a positive influence on cage vibrations and stresses.

Accuracy

High frequency spindles are fitted with bearings produced according to GMN standard grade UP. They are distinguished from international standards due to excellent running accuracy.

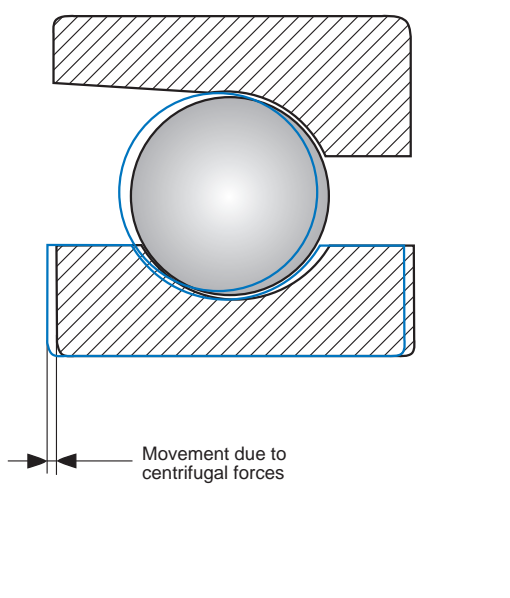

Radial runout of assembled bearing inner ring. Limits in micron [μm]

Bearing bore diameter [mm]	Tolerance class		
	P4/ABEC 7	P2/ABEC 9	UP
> 2.5...10	2.5	1.5	1.5
> 10...18	2.5	1.5	1.5
> 18...30	3.0	2.5	1.5
> 30...50	4.0	2.5	2.0
> 50...80	4.0	2.5	2.0

Assembled bearing outer ring face runout with raceway axial runout. Limits in micron [μm]

Bearing outside diameter [mm]	Tolerance class		
	P4/ABEC 7	P2/ABEC 9	UP
> 6...18	5.0	1.5	2.0
> 18...30	5.0	2.5	2.0
> 30...50	5.0	2.5	2.0
> 50...80	5.0	4.0	3.0
> 80..120	6.0	5.0	3.0

Spring preloaded single bearings

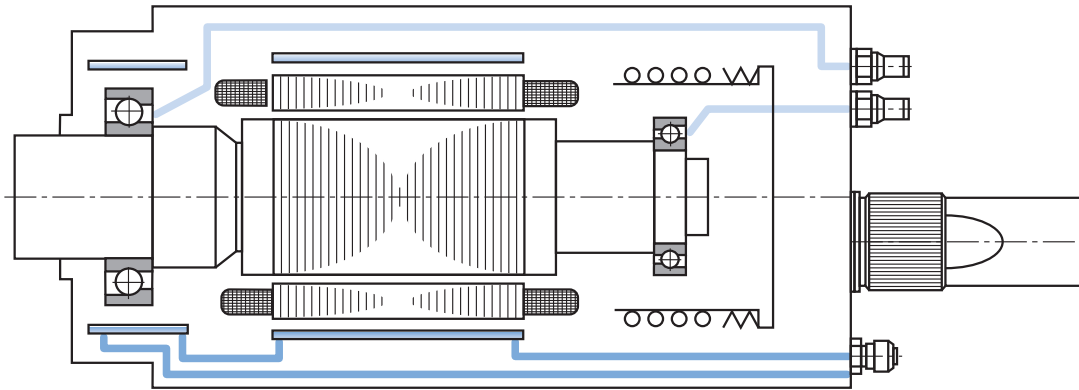

HS 80c - 180000/0.4
 HS 80c - 150000/0.5

HS 80c - 120000/1.1
 HS 80c - 90000/2

Spring preloaded bearing sets

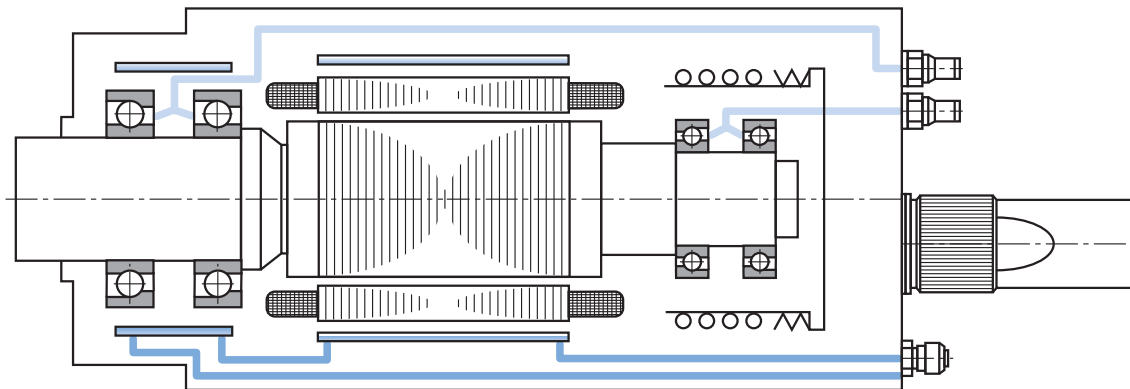

all other spindles

- > Short, rigid construction due to the high-frequency motor being placed between the bearing sets, results in favorable critical speeds, far exceeding the operating speed.
- > High stiffness and load carrying capacities.
- > Low vibration levels due to ultra precision bearings.
- > Minimal temperature variations due to liquid cooling of the motor and front bearings complement.
- > All mounting and critical datums are hardened and ground for longer service life.
- > Monitoring of motor temperature via temperature sensors.

Oil/air lubrication

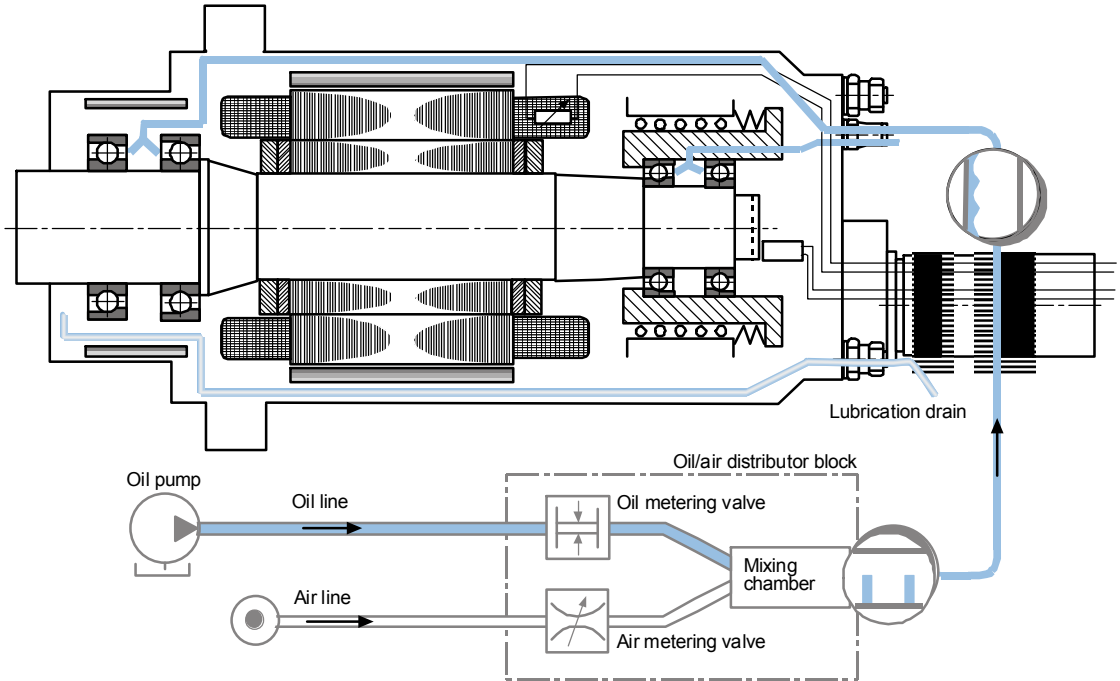

- > High reliability in operation due to separate supply to each bearing group and exact quantity of volume.
- > Ecological compatibility because of minimum oil consumption and elimination of oil mist.
- > Long life and high load carrying capacity as a result of the use of oils with additives like EP and HT.
- > Large spectrum of applicable oils.

Grease lubrication + air purge

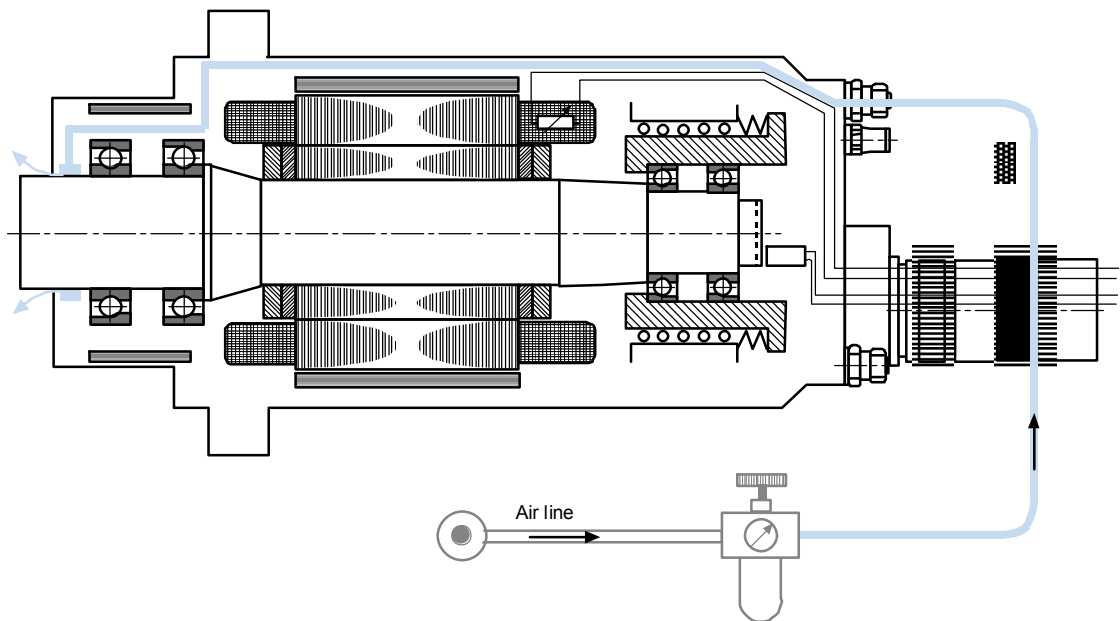

Coolant through the shaft with gap seal (du)

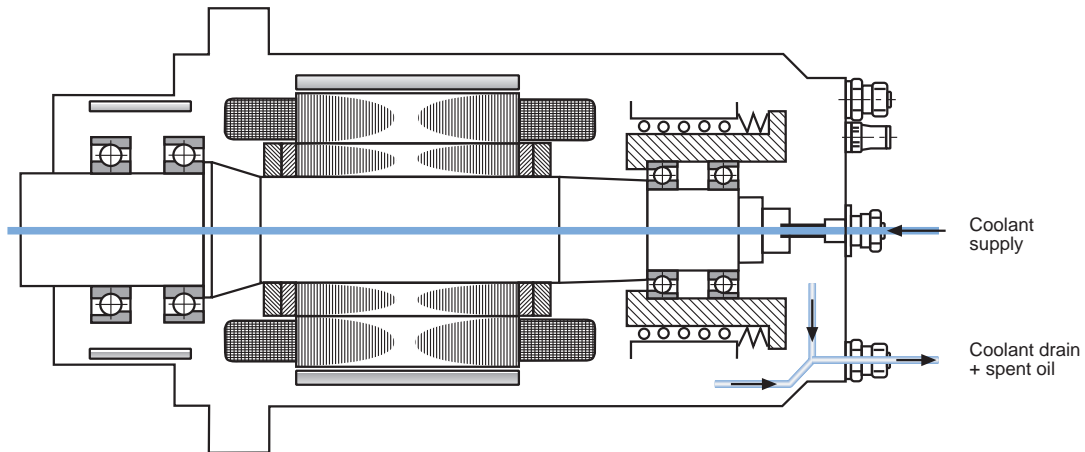

- > Maximum coolant pressure: 4 bar
- > Can be operated dry
- > Horizontal spindle mounting
- > Withstands pressure pulses
- > Coolant filtration: ≤ 0.1 mm

Coolant through the shaft with high pressure rotary union (dh)

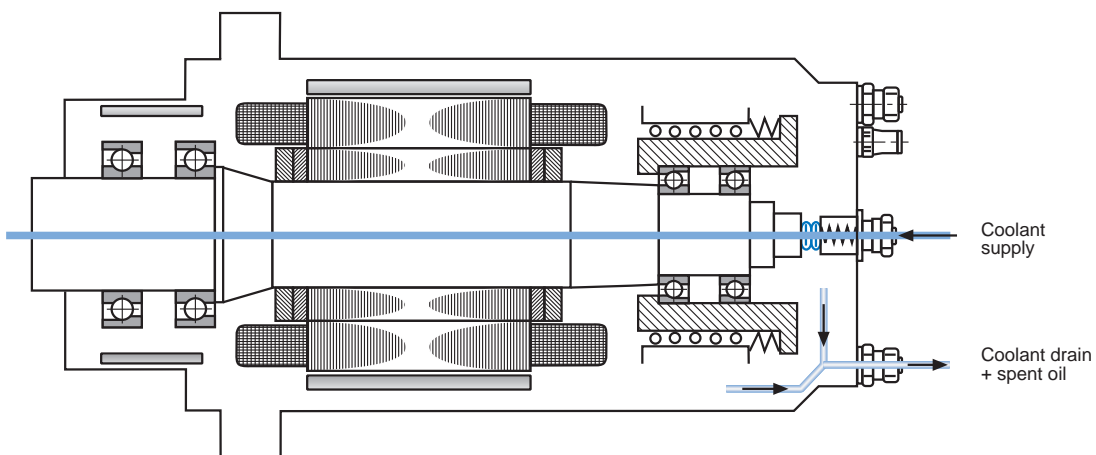

- > Maximum coolant pressure depends on the spindle type and seal design. Please consult GMN.
- > Minimum coolant pressure: 0.5 bar
- > Can be operated dry
- > Horizontal spindle mounting
- > Pressure pulsing must be avoided
- > Coolant filtration: ≤ 0.01 mm

On request, horizontal spindle mounting for both options

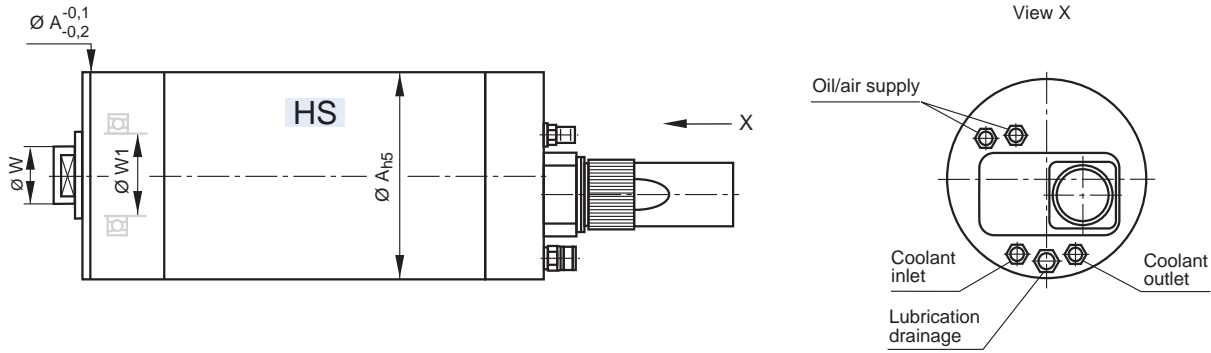

straight "GA" style electrical connector ¹⁾

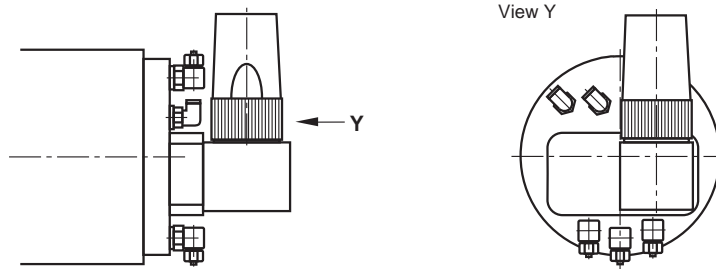

Option angled "GA" style electrical connector ¹⁾

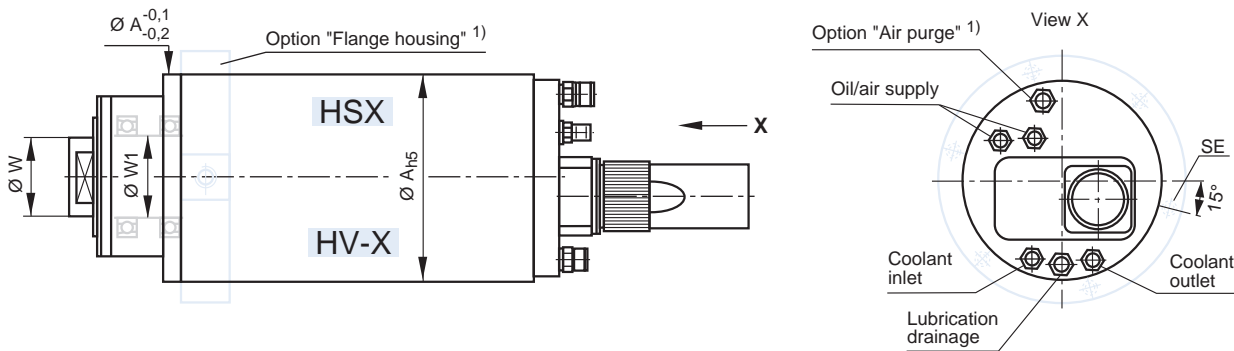

straight "GA" style electrical connector ¹⁾

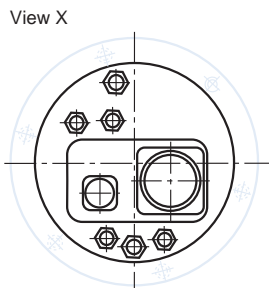

straight "MAC" style electrical connector ¹⁾

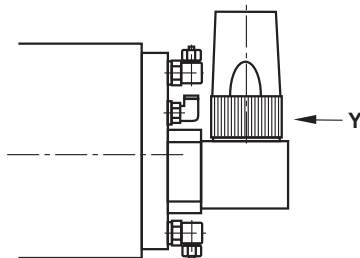

Option "angled connector" ¹⁾

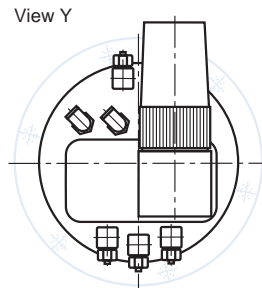

with angled "GA" style electrical connector ¹⁾

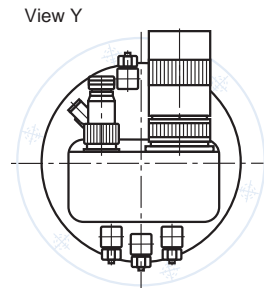

with angled "MAC" style electrical connector ¹⁾

¹⁾ Design options see pages 13, 15.
Edition 2508 / 2004-07-27

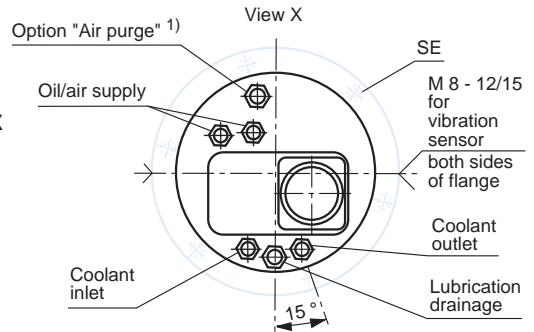
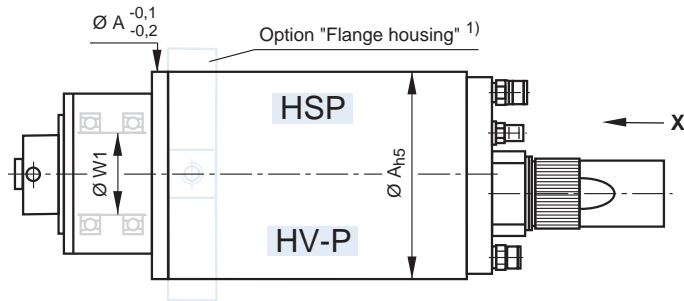

straight "GA" style electrical connector ¹⁾

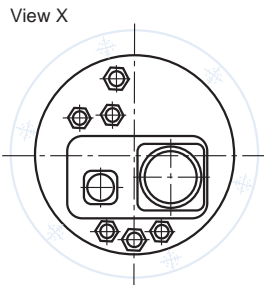

straight "MAC" style electrical connector ¹⁾

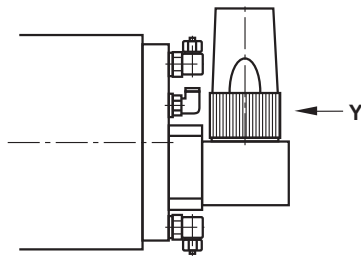

Option "angled connector" ¹⁾

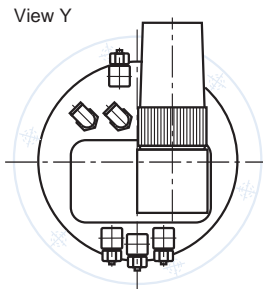

with angled "GA" style electrical connector ¹⁾

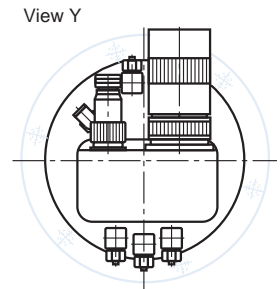

with angled "MAC" style electrical connector ¹⁾

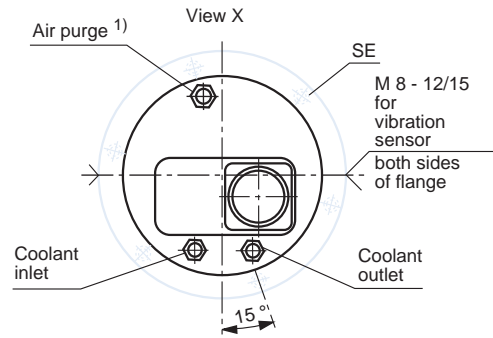
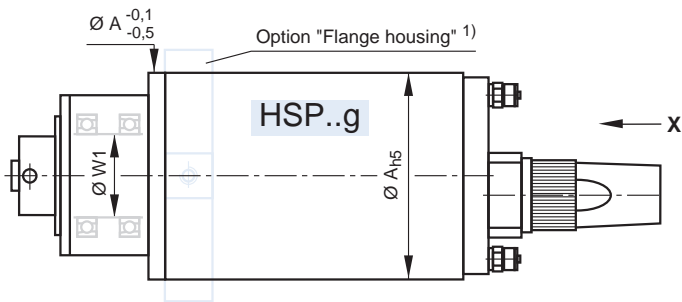

straight "GA" style electrical connector ¹⁾

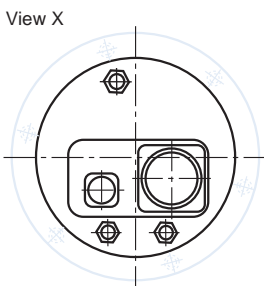

straight "MAC" style electrical connector ¹⁾

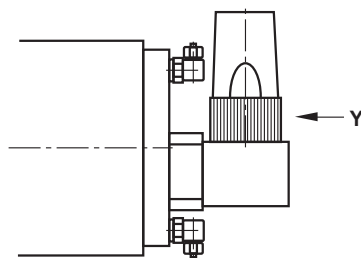

Option "angled connector" ¹⁾

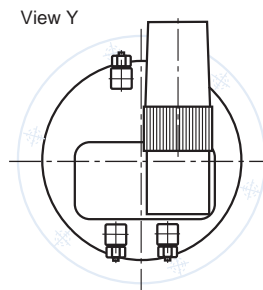

with angled "GA" style electrical connector ¹⁾

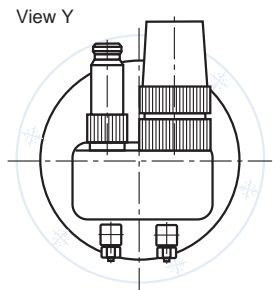

with angled "MAC" style electrical connector ¹⁾

¹⁾ Design options see pages 14, 15.
Edition 2508 / 2004-07-27

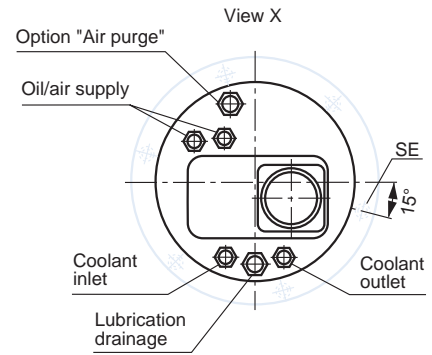
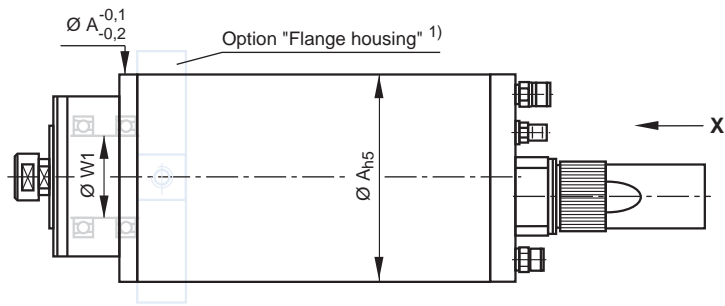

straight "GA" style electrical connector ¹⁾

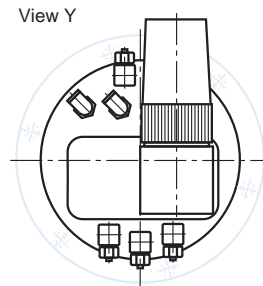
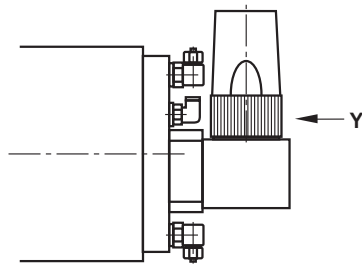

Option angled "GA" style electrical connector ¹⁾

1) Design options see page 13.

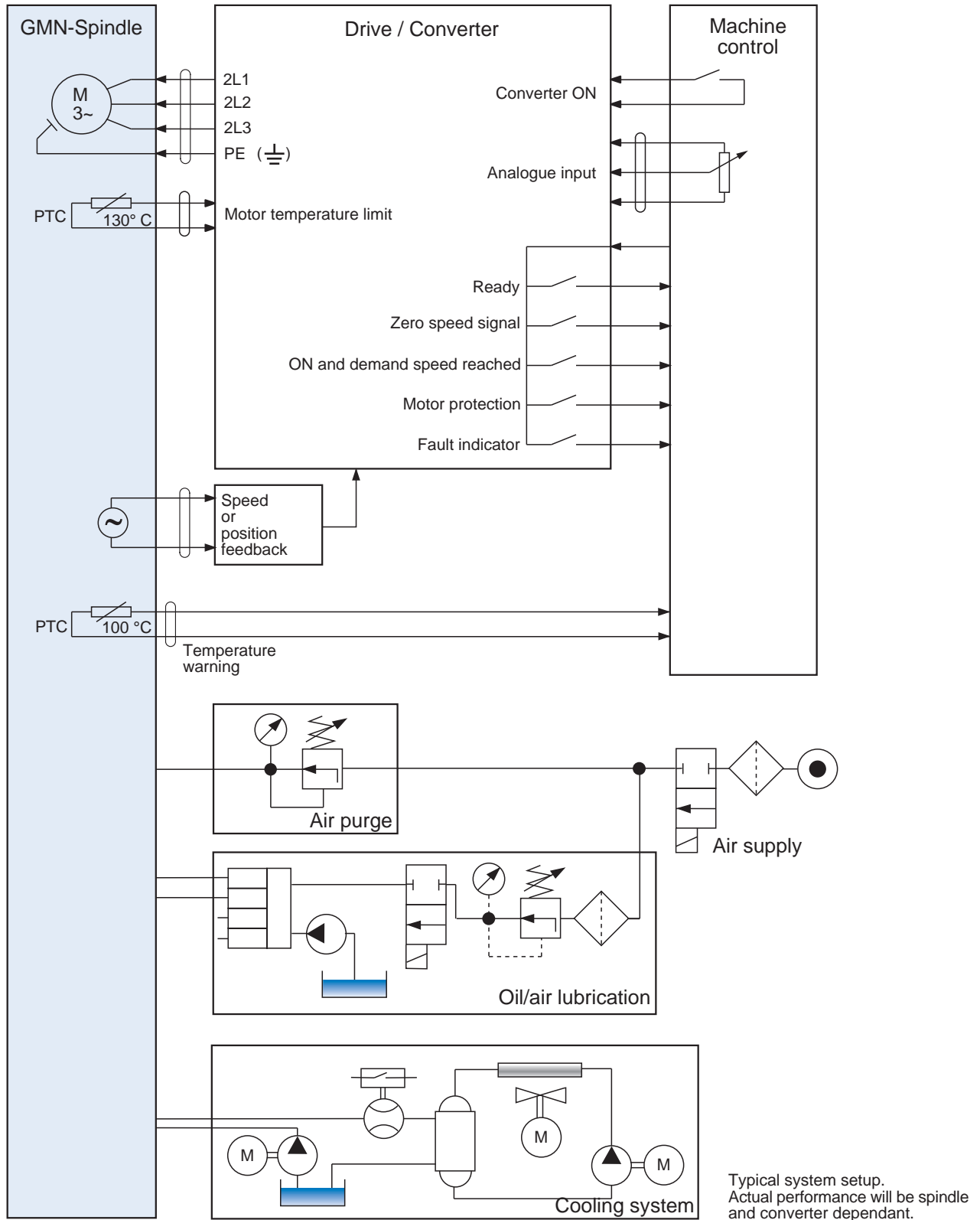

Designation	Tool interface	Features									Voltage [V]			Connector type		
		c	du	dh	DrS	DrG	WiS	SpL	Fla	350	220	460	GA	MAC	SV 35	
HS-T 80 - 120000 / 1.1	T 7	x	O	-	*	-	*	O	O	O	x	-	x	-	-	
HS-T 100 - 105000 / 2	T 7	x	O	-	x	-	O	O	O	x	O	*	x	-	-	
HS-T 100 - 90000 / 3	T 9	x	O	-	x	-	O	O	O	x	O	*	x	-	-	
HS-T 100 - 75000 / 5	T 12	x	O	-	x	-	O	O	O	x	O	*	x	-	-	
HS 80c - 180000 / 0.4	D 04/08	x	-	-	*	-	*	-	*	O	x	-	x	-	-	
HS 80c - 150000 / 0.5	D 04/08	x	-	-	*	-	*	-	*	O	x	-	x	-	-	
HS 80c - 120000 / 1.1	D 06/12	x	*	-	*	-	*	-	*	O	x	-	x	-	-	
HS 80c - 90000 / 2	D 08/14	x	*	-	*	-	*	-	*	x	O	-	x	-	-	
HSX 80 - 120000 / 1.1	D 06/12	x	O	-	*	-	*	O	O	O	x	-	x	-	-	
HSX 100 - 105000 / 2	D 08/14	x	O	-	x	-	O	O	O	x	O	*	x	-	-	
HSX 100 - 90000 / 3	D 09/16	x	O	-	x	-	O	O	O	x	O	*	x	-	-	
HSX 100 - 75000 / 5	D 10/18	x	O	-	x	-	O	O	O	x	O	*	x	-	-	
HSX 100 - 60000 / 5	D 14/23	x	O	-	x	-	O	O	O	x	O	*	x	-	-	
HSX 120 - 60000 / 7	D 14/23	x	O	-	x	*	O	O	O	x	O	*	x	-	-	
HSX 120 - 51000 / 12	D 16/28	x	O	-	x	*	O	O	O	x	+	*	x	O	-	
HSX 120 - 42000 / 12	D 22/38	x	O	-	x	*	O	O	O	x	-	*	x	O	-	
HSX 120 - 30000 / 13	D 28/43	x	O	-	x	*	O	O	O	x	-	*	x	O	-	
HSX 150 - 42000 / 16	D 22/38	x	O	-	x	*	O	O	O	x	+	*	-	x	-	
HSX 150 - 42000 / 11	D 22/38	x	O	-	x	*	O	O	O	x	-	*	x	O	-	
HSX 150 - 30000 / 23	D 32/53	x	-	O	x	*	O	O	O	x	-	O	-	x	-	
HSX 150 - 30000 / 16	D 32/53	x	-	O	x	*	O	O	O	x	+	*	x	O	-	
HSX 150 - 24000 / 23	D 36/63	x	-	O	x	*	O	O	O	x	-	O	-	x	-	
HSX 150 - 24000 / 17	D 36/63	x	-	O	x	*	O	O	O	x	+	*	x	O	-	
HSX 150 - 18000 / 17	D 36/63	x	-	O	x	*	O	O	O	x	+	*	x	O	-	
HSX 170 - 30000 / 35	D 32/53	x	-	O	x	*	O	O	O	x	-	O	-	x	-	
HSX 170 - 30000 / 21	D 23/53	x	-	O	x	*	O	O	O	x	-	O	-	x	-	
HSX 170 - 24000 / 35	D 36/63	x	-	O	x	*	O	O	O	x	-	O	-	x	-	
HSX 170 - 24000 / 21	D 36/63	x	-	O	x	*	O	O	O	x	-	O	-	x	-	
HSX 170 - 18000 / 34	D 36/68	x	-	O	x	*	O	O	O	x	-	O	-	x	-	
HSX 170 - 18000 / 23	D 36/68	x	-	O	x	*	O	O	O	x	-	O	-	x	-	

x Standard
 O Option
 * On request
 + On request, only with reduced output available

c: Hybrid bearings
 du: Coolant through shaft
 dh: High pressure rotary coolant union
 DrG: Encoder

DrS: Speed sensor
 WiS: Angled connector
 SpL: Air purge
 Fla: Flange housing

Colored styles indicate standard features and short delivery times.

Designation	Tool interface	Features												
		c	du	dh	DrS	WiS	SpL	Fla	Voltage [V]			Connector type		
									350	220	460	GA	MAC	SV 35
HSP 100 - 51000 / 5	HSK-C 25	x	*	-	x	O	*	O	x	O	-	x	-	-
HSP 100 - 51000 / 3	HSK-C 25	x	*	-	x	O	*	O	x	O	-	x	-	-
HSP 100 - 42000 / 5	HSK-C 32	x	*	-	x	O	*	O	x	O	-	x	-	-
HSP 100 - 42000 / 3	HSK-C 32	x	*	-	x	O	*	O	x	O	-	x	-	-
HSP 120 - 51000 / 11	HSK-C 25	x	O	-	x	O	O	O	x	-	*	x	O	-
HSP 120 - 51000 / 6	HSK-C 25	x	O	-	x	O	O	O	x	+	*	x	O	-
HSP 120 - 42000 / 11	HSK-C 32	x	O	-	x	O	O	O	x	-	*	x	O	-
HSP 120 - 42000 / 6	HSK-C 32	x	O	-	x	O	O	O	x	+	*	x	O	-
HSP 120 - 30000 / 11	HSK-C 40	x	O	-	x	O	O	O	x	-	*	x	O	-
HSP 120 - 30000 / 9	HSK-C 40	x	O	-	x	O	O	O	x	+	*	x	O	-
HSP 150 - 42000 / 14	HSK-C 32	x	O	-	x	O	O	O	x	-	*	O	x	-
HSP 150 - 42000 / 9	HSK-C 32	x	O	-	x	O	O	O	x	+	*	x	O	-
HSP 150 - 30000 / 18	HSK-C 50	x	-	O	x	O	O	O	x	-	O	O	x	-
HSP 150 - 30000 / 9	HSK-C 50	x	-	O	x	O	O	O	x	+	*	x	O	-
HSP 150 - 24000 / 18	HSK-C 63	x	-	O	x	O	O	O	x	-	O	O	x	-
HSP 150 - 24000 / 14	HSK-C 63	x	-	O	x	O	O	O	x	+	*	x	O	-
HSP 170 - 30000 / 32	HSK-C 50	x	-	O	x	O	O	O	x	-	O	-	x	-
HSP 170 - 30000 / 19	HSK-C 50	x	-	O	x	O	O	O	x	+	*	O	x	-
HSP 170 - 24000 / 32	HSK-C 63	x	-	O	x	O	O	O	x	-	O	-	x	-
HSP 170 - 24000 / 19	HSK-C 63	x	-	O	x	O	O	O	x	-	O	O	x	-
HSP 170 - 18000 / 29	HSK-C 63	x	-	O	x	O	O	O	x	-	O	-	x	-
HSP 170 - 18000 / 20	HSK-C 63	x	-	O	x	O	O	O	x	-	O	O	x	-
HSP 230 - 18000 / 45	HSK-C 63	x	-	O	x	O	O	O	x	-	O	-	-	x
HSP 230 - 18000 / 18	HSK-C 63	x	-	O	x	O	O	O	x	-	O	-	-	x
HSP 230 - 15000 / 42	HSK-C 80	x	-	O	x	O	O	O	x	-	O	-	-	x
HSP 230 - 15000 / 25	HSK-C 80	x	-	O	x	O	O	O	x	-	O	-	-	x
HSP 300 - 12000 / 30	HSK-C 100	x	-	O	x	O	O	O	x	-	O	-	-	x
HSP 100g - 30000 / 3	HSK-C 32	x	-	-	x	O	x	O	x	*	-	x	-	-
HSP 100g - 27000 / 3	HSK-C 32	x	-	-	x	O	x	O	x	*	-	x	-	-
HSP 100g - 21000 / 3	HSK-C 40	x	-	-	x	O	x	O	x	*	-	x	-	-
HSP 120g - 30000 / 6	HSK-C 25	x	-	-	x	O	x	O	x	*	O	x	O	-
HSP 120g - 24000 / 6	HSK-C 32	x	-	-	x	O	x	O	x	*	O	x	O	-
HSP 120g - 21000 / 9	HSK-C 40	x	-	-	x	O	x	O	x	*	O	x	O	-
HSP 150g - 24000 / 9	HSK-C 32	x	-	-	x	O	x	O	x	-	O	x	O	-
HSP 150g - 18000 / 9	HSK-C 50	x	-	O	x	O	x	O	x	-	O	x	O	-
HSP 150g - 15000 / 14	HSK-C 63	x	-	O	x	O	x	O	x	-	O	x	O	-
HSP 170g - 18000 / 19	HSK-C 50	x	-	O	x	O	x	O	x	-	O	-	x	-
HSP 170g - 15000 / 19	HSK-C 63	x	-	O	x	O	x	O	x	-	O	-	x	-
HSP 170g - 12000 / 20	HSK-C 63	x	-	O	x	O	x	O	x	-	O	-	x	-
HSP 230g - 12000 / 18	HSK-C 63	x	-	O	x	O	x	O	x	-	O	-	-	x
HSP 230g - 10000 / 25	HSK-C 80	x	-	O	x	O	x	O	x	-	O	-	-	x
HSP 300g - 8000 / 30	HSK-C 100	x	-	O	x	O	x	O	x	-	O	-	-	x

x Standard
O Option
* On request
+ On request, only with reduced output available

c: Hybrid bearings
du: Coolant through shaft
dh: High pressure rotary coolant union
DrS: Speed sensor

WiS: Angled connector
SpL: Air purge
Fla: Flange housing

Designation	Tool interface	Features										Voltage [V]			Connector type		
		c	du	dh	DrS	DrG	WiS	SpL	Fla	350	220	460	GA	MAC	SV 35		
HV-X 100 - 105000 / 2	D 09/16	x	O	-	x	-	O	O	O	x	O	*	x	-	-		
HV-X 100 - 90000 / 3	D 10/18	x	O	-	x	-	O	O	O	x	O	*	x	-	-		
HV-X 100 - 75000 / 5	D 14/23	x	O	-	x	-	O	O	O	x	O	*	x	-	-		
HV-X 100 - 60000 / 9	D 16/28	x	O	-	x	-	O	O	O	x	O	*	x	-	-		
HV-X 100 - 45000 / 9	D 22/38	x	O	-	x	-	O	O	O	x	O	*	x	-	-		
HV-X 100 - 30000 / 9	D 28/43	x	O	-	x	-	O	O	O	x	O	*	x	-	-		
HV-X 120 - 75000 / 7	D 14/23	x	O	-	x	O	O	O	O	x	O	O	x	*	-		
HV-X 120 - 60000 / 13	D 16/28	x	O	-	x	O	O	O	O	x	+	O	x	*	-		
HV-X 120 - 60000 / 12	D 16/28	x	O	-	x	O	O	O	O	x	O	O	x	*	-		
HV-X 120 - 45000 / 18	D 28/43	x	O	O	x	O	O	O	O	x	+	O	x	*	-		
HV-X 120 - 30000 / 18	D 32/53	x	O	O	x	O	O	O	O	x	+	O	x	*	-		
HV-X 150 - 45000 / 36	D 28/43	x	*	O	x	O	O	O	O	x	-	O	-	x	O		
HV-X 150 - 45000 / 25	D 28/43	x	*	O	x	O	O	O	O	x	+	O	-	x	O		
HV-X 150 - 30000 / 37	D 36/63	x	*	O	x	O	O	O	O	x	-	O	-	x	O		
HV-X 150 - 30000 / 26	D 36/63	x	*	O	x	O	O	O	O	x	+	O	-	x	O		
HV-P 100 - 60000 / 9	HSK-C 25	x	*	-	x	-	O	O	O	x	O	*	x	-	-		
HV-P 100 - 45000 / 9	HSK-C 32	x	*	-	x	-	O	O	O	x	O	*	x	-	-		
HV-P 100 - 30000 / 9	HSK-C 40	x	*	-	x	-	O	O	O	x	O	*	x	-	-		
HV-P 120 - 60000 / 13	HSK-C 25	x	*	-	x	O	O	O	O	x	+	O	x	*	-		
HV-P 120 - 60000 / 12	HSK-C 25	x	*	-	x	O	O	O	O	x	O	O	x	*	-		
HV-P 120 - 45000 / 18	HSK-C 40	x	*	O	x	O	O	O	O	x	+	O	x	*	-		
HV-P 120 - 30000 / 18	HSK-C 50	x	*	O	x	O	O	O	O	x	+	O	x	*	-		
HV-P 150 - 45000 / 36	HSK-C 40	x	*	O	x	O	O	O	O	x	-	O	-	x	O		
HV-P 150 - 45000 / 25	HSK-C 40	x	*	O	x	O	O	O	O	x	+	O	-	x	O		
HV-P 150 - 30000 / 37	HSK-C 63	x	*	O	x	O	O	O	O	x	-	O	-	x	O		
HV-P 150 - 30000 / 26	HSK-C 63	x	*	O	x	O	O	O	O	x	+	O	-	x	O		

x Standard
 O Option
 * On request

+ On request, only with reduced output available

c: Hybrid bearings

du: Coolant through shaft

dh: High pressure rotary coolant union

DrG: Encoder

DrS: Speed sensor

WiS: Angled connector

SpL: Air purge

Fla: Flange housing

Colored styles indicate standard features and short delivery times.

Designation	Tool interface D [d] / [W] ¹⁾	Designation	Tool interface HSK T [d] ²⁾	Speed max. n _{max} [rpm]	Bearing bore W1 [mm]	Static stiffness		Power specifications		
						axial [N/μm]	radial [N/μm]	Torque M _{S6} [Nm]	Output S6-60% at speed	
									P _{S6} [kW]	n [rpm]
HS 80c - 180000 / 0.4	D 04/08			180 000	8	8	15	0.02	0.4	180 000
HS 80c - 150000 / 0.5	D 04/08			150 000	8	9	15	0.03	0.5	150 000
HS 80c - 120000 / 1.1	D 06/12			120 000	12	11	21	0.09	1.1	120 000
HS 80c - 90000 / 2	D 08/14			90 000	15	17	28	0.21	2	90 000
HSX 80 - 120000 / 1.1	D 06/12	HS-T 80 - 120000 / 1.1	T 7	120 000	12	22	24	0.09	1.1	120 000
HSX 100 - 105000 / 2	D 08/14	HS-T 100 - 105000 / 2	T 7	105 000	15	26	29	0.2	2	105 000
HSX 100 - 90000 / 3	D 09/16	HS-T 100 - 90000 / 3	T 9	90 000	17	36	33	0.3	3	90 000
HSX 100 - 75000 / 5	D 10/18	HS-T 100 - 75000 / 5	T 12	75 000	20	48	46	0.6	5	75 000
HSX 100 - 60000 / 5	D 14/23			60 000	25	53	53	0.8	5	60 000
		HSP 100 - 51000 / 5	HSK-C 25	51 000	30	63	77	1.6	6	36 000
		HSP 100 - 51000 / 3	HSK-C 25	51 000	30	63	77	1.6	4	24 000
		HSP 100 - 42000 / 5	HSK-C 32	42 000	35	69	81	1.6	6	36 000
		HSP 100 - 42000 / 3	HSK-C 32	42 000	35	69	81	1.6	4	24 000
HSX 120 - 60000 / 7	D 14/23			60 000	25	54	57	1.1	7	60 000
HSX 120 - 51000 / 12	D 16/28	HSP 120 - 51000 / 11	HSK-C 25	51 000	30	70	102	3.8	12	30 000
HSX 120 - 42000 / 12	D 22/38	HSP 120 - 42000 / 11	HSK-C 32	42 000	40	90	130	3.8	12	30 000
HSX 120 - 30000 / 13	D 28/43	HSP 120 - 30000 / 11	HSK-C 40	30 000	45	98	131	6.6	13	18 000
		HSP 120 - 51000 / 6	HSK-C 25	51 000	30	70	102	3.7	7	18 000
		HSP 120 - 42000 / 6	HSK-C 32	42 000	40	90	130	3.7	7	18 000
		HSP 120 - 30000 / 9	HSK-C 40	30 000	45	98	131	6.9	13	18 000
HSX 150 - 42000 / 16	D 22/38	HSP 150 - 42000 / 14	HSK-C 32	42 000	40	90	147	5.7	16	27 000
HSX 150 - 42000 / 11	D 22/38			42 000	40	90	147	5.8	11	18 000
HSX 150 - 30000 / 23	D 32/53	HSP 150 - 30000 / 18	HSK-C 50	30 000	55	111	177	12.2	23	18 000
HSX 150 - 30000 / 16	D 32/53			30 000	55	111	177	11.3	16	13 500
HSX 150 - 24000 / 23	D 36/63	HSP 150 - 24000 / 18	HSK-C 63	24 000	65	130	196	12.2	23	18 000
HSX 150 - 24000 / 17	D 36/63	HSP 150 - 24000 / 14	HSK-C 63	24 000	65	130	196	14.8	17	11 000
HSX 150 - 18000 / 17	D 36/63			18 000	65	185	218	14.8	17	11 000
		HSP 150 - 42000 / 9	HSK-C 32	42 000	40	90	147	5.8	11	18 000
		HSP 150 - 30000 / 9	HSK-C 50	30 000	55	111	177	12.2	14	11 000
HSX 170 - 30000 / 35	D 32/53	HSP 170 - 30000 / 32	HSK-C 50	30 000	55	111	203	22.3	35	15 000
HSX 170 - 30000 / 21	D 32/53	HSP 170 - 30000 / 19	HSK-C 50	30 000	55	111	203	22.3	21	9 000
HSX 170 - 24000 / 35	D 36/63	HSP 170 - 24000 / 32	HSK-C 63	24 000	65	130	231	22.3	35	15 000
HSX 170 - 24000 / 21	D 36/63	HSP 170 - 24000 / 19	HSK-C 63	24 000	65	130	231	22.3	21	9 000
HSX 170 - 18000 / 34	D 36/68	HSP 170 - 18000 / 29	HSK-C 63	18 000	70	201	325	29.5	34	11 000
HSX 170 - 18000 / 23	D 36/68	HSP 170 - 18000 / 20	HSK-C 63	18 000	70	201	325	29.3	23	7 500

1) See table page 47.

2) See table page 52.

3) For different voltages, see page 13, 14.

Power specifications										Designation	Tool interface	Designation	
Torque M_{S1} [Nm]	Continuous power S1			Voltage at frequency			Current		Tool interface HSK T [d]				D [d] / [W]
	P_{S1} [kW]	from...up to		$U_n^{3)}$ [V]	f_K [Hz]	f_{max} [Hz]	I_{S6} [A]	I_{S1} [A]					
	n_0 [rpm]	n_1 [rpm]											
				220		3 000		2.0				HS 80c - 180000 / 0.4	
				220		2 500		2.5				HS 80c - 150000 / 0.5	
				220		2 000		6.5				HS 80c - 120000 / 1.1	
				350		1 500		6				HS 80c - 90000 / 2	
				220		2 000		6	T 7	HS-T 80 - 120000 / 1.1		HSX 80 - 120000 / 1,1	
0.15	1.7	105 000		350		1 750		6,5	5	T 7	HS-T100 - 105000 / 2	D 08/14	HSX 100 - 105000 / 2
0.27	2.5	90 000		350		1 500		9	7,5	T 9	HS-T100 - 90000 / 3	D 09/16	HSX 100 - 90000 / 3
0.51	4	75 000		350		1 250		13	10,5	T 12	HS-T100 - 75000 / 5	D 10/18	HSX 100 - 75000 / 5
0.64	4	60 000		350		1 000		13	10,5			D 14/23	HSX 100 - 60000 / 5
1.4	5	36 000	42 000	350	1 200	1 700		18	15	HSK-C 25	HSP 100 - 51000 / 5		
1.4	3	21 000	30 000	350	800	1 700		12	10	HSK-C 25	HSP 100 - 51000 / 3		
1.4	5	36 000	42 000	350	1 200	1 400		18	15	HSK-C 32	HSP 100 - 42000 / 5		
1.4	3	21 000	30 000	350	800	1 400		12	10	HSK-C 32	HSP 100 - 42000 / 3		
1	6	60 000		350		1 000		18	16			D 14/23	HSX 120 - 60000 / 7
3.5	11	30 000	42 000	350	1 200	1 700		38	36	HSK-C 25	HSP 120 - 51000 / 11	D 16/28	HSX 120 - 51000 / 12
3.5	11	30 000	42 000	350	1 200	1 400		38	36	HSK-C 32	HSP 120 - 42000 / 11	D 22/38	HSX 120 - 42000 / 12
5.8	11	18 000	30 000	350	1 200	1 500		48	41	HSK-C 40	HSP 120 - 30000 / 11	D 28/43	HSX 120 - 30000 / 13
3.2	6	18 000	30 000	350	600	1 700		20	17	HSK-C 25	HSP 120 - 51000 / 6		
3.2	6	18 000	30 000	350	600	1 400		20	17	HSK-C 32	HSP 120 - 42000 / 6		
5.7	9	15 000	24 000	350	900	1 500		36	30	HSK-C 40	HSP 120 - 30000 / 9		
5	14	27 000	42 000	350	1 000	1 400		58	49	HSK-C 32	HSP 150 - 42000 / 14	D 22/38	HSX 150 - 42000 / 16
5	9.5	18 000	30 000	350	600	1 400		31	27			D 22/38	HSX 150 - 42000 / 11
9.5	18	18 000	30 000	350	600	1 000		63	49	HSK-C 50	HSP 150 - 30000 / 18	D 32/53	HSX 150 - 30000 / 23
9.9	14	13 500		350	450	1 000		40	36			D 32/53	HSX 150 - 30000 / 16
9.5	18	18 000	24 000	350	600	800		63	49	HSK-C 63	HSP 150 - 24000 / 18	D 36/63	HSX 150 - 24000 / 23
12.2	14	11 000	16 000	350	367	800		45	37	HSK-C 63	HSP 150 - 24000 / 14	D 36/63	HSX 150 - 24000 / 17
12.2	14	11 000	16 000	350	367	600		45	37			D 36/63	HSX 150 - 18000 / 17
4.8	9	18 000	30 000	350	600	1 400		36	29	HSK-C 32	HSP 150 - 42000 / 9		
11.5	9	7 500	21 000	350	367	1 000		38	35	HSK-C 50	HSP 150 - 30000 / 9		
20.4	32	15 000	30 000	350	500	1 000		86	80	HSK-C 50	HSP 170 - 30000 / 32	D 32/53	HSX 170 - 30000 / 35
20.2	19	9 000	18 000	350	300	1 000		53	51	HSK-C 50	HSP 170 - 30000 / 19	D 32/53	HSX 170 - 30000 / 21
20.4	32	15 000	24 000	350	500	800		86	80	HSK-C 63	HSP 170 - 24000 / 32	D 36/63	HSX 170 - 24000 / 35
20.2	19	9 000	18 000	350	367	800		53	47	HSK-C 63	HSP 170 - 24000 / 19	D 36/63	HSX 170 - 24000 / 21
25.2	29	11 000	18 000	350	367	600		78	67	HSK-C 63	HSP 170 - 18000 / 29	D 36/68	HSX 170 - 18000 / 34
25.5	20	7 500	12 000	350	250	600		58	51	HSK-C 63	HSP 170 - 18000 / 20	D 36/68	HSX 170 - 18000 / 23

Designation	Oil/air lubrication n_{max} [rpm]	Designation	Permanent grease lubrication n_{max} [rpm]	Tool interface HSK	Bearing bore W1 [mm]	Static stiffness		Power specifications		
						axial [N/μm]	radial [N/μm]	Torque M_{S6} [Nm]	Output S6-60% at speed	
									P_{S6} [kW]	n [rpm]
HSP 100 - 51000 / 5	51 000			HSK-C 25	30	63	77	1.6	6	36 000
HSP 100 - 51000 / 3	51 000	HSP 100g - 30000 / 3	30 000	HSK-C 25	30	63	77	1.6	4	24 000
HSP 100 - 42000 / 5	42 000			HSK-C 32	35	69	81	1.6	6	36 000
HSP 100 - 42000 / 3	42 000	HSP 100g - 27000 / 3	27 000	HSK-C 32	35	69	81	1.6	4	24 000
		HSP 100g - 21000 / 3	21 000	HSK-C 40	45	91	80	3	4.5	15 000
HSP 120 - 51000 / 11	51 000			HSK-C 25	30	70	102	3.8	12	30 000
HSP 120 - 51000 / 6	51 000	HSP 120g - 30000 / 6	30 000	HSK-C 25	30	70	102	3.7	7	18 000
HSP 120 - 42000 / 11	42 000			HSK-C 32	40	90	130	3.8	12	30 000
HSP 120 - 42000 / 6	42 000	HSP 120g - 24000 / 6	24 000	HSK-C 32	40	90	130	3.7	7	18 000
HSP 120 - 30000 / 11	30 000			HSK-C 40	45	98	131	6.6	13	18 000
HSP 120 - 30000 / 9	30 000	HSP 120g - 21000 / 9	21 000	HSK-C 40	45	98	131	6.9	13	18 000
HSP 150 - 42000 / 14	42 000			HSK-C 32	40	90	147	5.7	16	27 000
HSP 150 - 42000 / 9	42 000	HSP 150g - 24000 / 9	24 000	HSK-C 32	40	90	147	5.8	11	18 000
HSP 150 - 30000 / 18	30 000			HSK-C 50	55	111	177	12.2	23	18 000
HSP 150 - 30000 / 9	30 000	HSP 150g - 18000 / 9	18 000	HSK-C 50	55	111	177	12.2	14	11 000
HSP 150 - 24000 / 18	24 000			HSK-C 63	65	130	196	12.2	23	18 000
HSP 150 - 24000 / 14	24 000	HSP 150g - 15000 / 14	15 000	HSK-C 63	65	130	196	14.8	17	11 000
HSP 170 - 30000 / 32	30 000			HSK-C 50	55	111	203	22.3	35	15 000
HSP 170 - 30000 / 19	30 000			HSK-C 50	55	111	203	22.3	21	9 000
HSP 170 - 24000 / 32	24 000			HSK-C 63	65	130	231	22.3	35	15 000
HSP 170 - 24000 / 19	24 000			HSK-C 63	65	130	231	22.3	21	9 000
HSP 170 - 18000 / 29	18 000			HSK-C 63	70	172	162	29.5	34	11 000
HSP 170 - 18000 / 20	18 000			HSK-C 63	70	172	162	29.3	23	7 500
		HSP 170g - 18000 / 19	18 000	HSK-C 50	55	111	203	21	22	10 000
		HSP 170g - 15000 / 19	15 000	HSK-C 63	65	130	231	21	22	10 000
		HSP 170g - 12000 / 20	12 000	HSK-C 63	70	196	325	29.3	23	7 500
HSP 230 - 18000 / 45	18 000			HSK-C 63	70	196	375	65	50	7 300
HSP 230 - 18000 / 18	18 000	HSP 230g - 12000 / 18	12 000	HSK-C 63	70	196	375	65	20	2 900
HSP 230 - 15000 / 42	15 000			HSK-C 80	90	461	483	95	47	4 700
HSP 230 - 15000 / 25	15 000	HSP 230g - 10000 / 25	10 000	HSK-C 80	90	461	483	95	28	2 800
HSP 300 - 12000 / 30	12 000	HSP 300g - 8000 / 30	8 000	HSK-C 100	110	607	660	325	34	1 000

1) For different voltages, see page 14.

Power specifications										Tool interface	Designation	Designation	
Torque	Continuous power S1				Voltage 350 V ¹⁾ at frequency			Current					HSK
	M _{S1} [Nm]	P _{S1} [kW]	from.....up to		f _K [Hz]	from.....up to		I _{S6} [A]	I _{S1} [A]				
		n ₀ [rpm]	Oil/air n ₁ [rpm]	Grease n ₁ [rpm]		Oil/air f _{max} [Hz]	Grease f _{max} [Hz]						
1.4	5	36 000	42 000		1 200	1 700		18	15	HSK-C 25		HSP 100 - 51000 / 5	
1.4	3	21 000	30 000	30 000	800	1 700	1 000	12	10	HSK-C 25	HSP 100g - 30000 / 3	HSP 100 - 51000 / 3	
1.4	5	36 000	42 000		1 200	1 400		18	15	HSK-C 32		HSP 100 - 42000 / 5	
1.4	3	21 000	30 000	27 000	800	1 400	900	12	10	HSK-C 32	HSP 100g - 27000 / 3	HSP 100 - 42000 / 3	
2.4	3	12 000		21 000	500		700	12	10	HSK-C 40	HSP 100g - 21000 / 3		
3.5	11	30 000	42 000		1 200	1 700		38	36	HSK-C 25		HSP 120 - 51000 / 11	
3.2	6	18 000	30 000	30 000	600	1 700	1 000	20	17	HSK-C 25	HSP 120g - 30000 / 6	HSP 120 - 51000 / 6	
3.5	11	30 000	42 000		1 200	1 400		38	36	HSK-C 32		HSP 120 - 42000 / 11	
3.2	6	18 000	30 000	24 000	600	1 400	800	20	17	HSK-C 32	HSP 120g - 24000 / 6	HSP 120 - 42000 / 6	
5.8	11	18 000	30 000		1 200	1 500		48	41	HSK-C 40		HSP 120 - 30000 / 11	
5.7	9	15 000	24 000	21 000	900	1 500	1 050	36	30	HSK-C 40	HSP 120g - 21000 / 9	HSP 120 - 30000 / 9	
5	14	27 000	42 000		1 000	1 400		58	49	HSK-C 32		HSP 150 - 42000 / 14	
4.8	9	18 000	30 000	24 000	600	1 400	800	36	29	HSK-C 32	HSP 150g - 24000 / 9	HSP 150 - 42000 / 9	
9.5	18	18 000	30 000		600	1 000		63	49	HSK-C 50		HSP 150 - 30000 / 18	
11.5	9	7 500	21 000	18 000	367	1 000	600	38	35	HSK-C 50	HSP 150g - 18000 / 9	HSP 150 - 30000 / 9	
9.5	18	18 000	24 000		600	800		63	49	HSK-C 63		HSP 150 - 24000 / 18	
12.2	14	11 000	16 000	15 000	367	800	500	45	37	HSK-C 63	HSP 150g - 15000 / 14	HSP 150 - 24000 / 14	
20.4	32	15 000	30 000		500	1 000		86	80	HSK-C 50		HSP 170 - 30000 / 32	
20.2	19	9 000	18 000		300	1 000		53	51	HSK-C 50		HSP 170 - 30000 / 19	
20.4	32	15 000	24 000		500	800		86	80	HSK-C 63		HSP 170 - 24000 / 32	
20.2	19	9 000	18 000		367	800		53	47	HSK-C 63		HSP 170 - 24000 / 19	
25.5	29	11 000	18 000		367	600		78	67	HSK-C 63		HSP 170 - 18000 / 29	
25.5	20	7 500	12 000		250	600		58	51	HSK-C 63		HSP 170 - 18000 / 20	
20	19	9 000		18 000	367		600	53	47	HSK-C 50	HSP 170g - 18000 / 19		
20	19	9 000		15 000	367		500	53	47	HSK-C 63	HSP 170g - 15000 / 19		
25.5	20	7 500		12 000	250		600	58	51	HSK-C 63	HSP 170g - 12000 / 20		
59	45	7 300	13 000		250	600		108	98	HSK-C 63		HSP 230 - 18000 / 45	
59	18	2 900	9 000	9 000	145	600	400	64	57	HSK-C 63	HSP 230g - 12000 / 18	HSP 230 - 18000 / 18	
85	42	4 700	12 000		200	500		107	96	HSK-C 80		HSP 230 - 15000 / 42	
85	25	2 800	8 000	8 000	134	500	333	77	69	HSK-C 80	HSP 230g - 10000 / 25	HSP 230 - 15000 / 25	
286	30	1 000	10 000	8 000	90	600	400	136	120	HSK-C 100	HSP 300g - 8000 / 30	HSP 300 - 12000 / 30	

Designation	Tool interface D [d] / [W] ¹⁾	Designation	Tool interface HSK	Speed max. n _{max} [rpm]	Bearing bore W1 [mm]	Static stiffness		Power specifications		
						axial [N/μm]	radial [N/μm]	Torque M _{S6} [Nm]	Output S6-60% at speed	
									P _{S6} [kW]	n [rpm]
HV-X 100 - 105000 / 2	D 09/16			105 000	16	33	35	0.18	2	105 000
HV-X 100 - 90000 / 3	D 10/18			90 000	18	37	40	0.3	3	90 000
HV-X 100 - 75000 / 5	D 14/23			75 000	23	53	56	0.6	5	75 000
HV-X 100 - 60000 / 9	D 16/28	HV-P 100 - 60000/9	HSK-C 25	60 000	28	62	73	1.7	9	51 000
HV-X 100 - 45000 / 9	D 22/38	HV-P 100 - 45000/9	HSK-C 32	45 000	38	76	85	2.9	9	30 000
HV-X 100 - 30000 / 9	D 28/43	HV-P 100 - 30000/9	HSK-C 40	30 000	43	80	74	4.1	9	21 000
HV-X 120 - 75000 / 7	D 14/23			75 000	23	54	68	0.9	7	75 000
HV-X 120 - 60000 / 13	D 16/28	HV-P 120 - 60000/13	HSK-C 25	60 000	28	69	97	4.1	13	30 000
HV-X 120 - 60000 / 12	D 16/28	HV-P 120 - 60000/12	HSK-C 25	60 000	28	69	97	2.2	12	51 000
HV-X 120 - 45000 / 18	D 28/43	HV-P 120 - 45000/18	HSK-C 40	45 000	43	91	125	5.7	18	30 000
HV-X 120 - 30000 / 18	D 32/53	HV-P 120 - 30000/18	HSK-C 50	30 000	53	99	145	7.2	18	24 000
HV-X 150 - 45000 / 36	D 28/43	HV-P 150 - 45000/36	HSK-C 40	45 000	43	91	150	11.5	36	30 000
HV-X 150 - 45000 / 25	D 28/43	HV-P 150 - 45000/25	HSK-C 40	45 000	43	91	150	11.4	25	21 000
HV-X 150 - 30000 / 37	D 36/63	HV-P 150 - 30000/37	HSK-C 63	30 000	63	121	197	16.8	37	21 000
HV-X 150 - 30000 / 26	D 36/63	HV-P 150 - 30000/26	HSK-C 63	30 000	65	121	197	16.5	26	15 000

1) See table page 47.

2) For different voltages, see page 15.

Power specifications									Tool interface	Designation	Tool interface	Designation
Torque	Continuous power S1			Voltage at frequency			Current					
	M_{S1} [Nm]	P_{S1} [kW]	from...up to		$U_n^{2)}$ [V]	from...up to		I_{S6} [A]				
n_0 [rpm]			n_1 [rpm]	f_K [Hz]		f_{max} [Hz]	D [d] / [W]					
0.16	1.8	105 000		350	1 750		6	5.5			D 09/16	HV-X 100 - 105000 / 2
0.26	2.5	90 000		350	1 500		9	7.5			D 10/18	HV-X 100 - 90000 / 3
0.5	4	75 000		350	1 250		13	10.5			D 14/23	HV-X 100 - 75000 / 5
1.4	7.5	51 000	60 000	350	1 700	2 000	28	24	HSK-C 25	HV-P 100 - 60000 / 9	D 16/28	HV-X 100 - 60000 / 9
2.4	7.5	30 000	45 000	350	1 000	1 500	28	24	HSK-C 32	HV-P 100 - 45000 / 9	D 22/38	HV-X 100 - 45000 / 9
3.4	7.5	21 000	30 000	350	700	1 000	30	28	HSK-C 40	HV-P 100 - 30000 / 9	D 28/43	HV-X 100 - 30000 / 9
0.8	6	75 000		350	1 250		24	18			D 14/23	HV-X 120 - 75000 / 7
3.5	11	30 000	60 000	350	1 000	2 000	37	33	HSK-C 25	HV-P 120 - 60000 / 13	D 16/28	HV-X 120 - 60000 / 13
2	10.5	51 000	60 000	350	850	1 000	29	25	HSK-C 25	HV-P 120 - 60000 / 12	D 16/28	HV-X 120 - 60000 / 12
4.8	15	30 000	45 000	350	1 000	1 500	51	41	HSK-C 40	HV-P 120 - 45000 / 18	D 28/43	HV-X 120 - 45000 / 18
6	15	24 000	30 000	350	800	1 000	51	41	HSK-C 50	HV-P 120 - 30000 / 18	D 32/53	HV-X 120 - 30000 / 18
10.2	32	30 000	45 000	350	1 000	1 500	95	87	HSK-C 40	HV-P 150 - 45000 / 36	D 28/43	HV-X 150 - 45000 / 36
10	22	21 000	30 000	350	700	1 500	67	60	HSK-C 40	HV-P 150 - 45000 / 25	D 28/43	HV-X 150 - 45000 / 25
15	33	21 000	30 000	350	700	1 000	92	84	HSK-C 63	HV-P 150 - 30000 / 37	D 36/63	HV-X 150 - 30000 / 37
14.7	23	15 000	22 000	350	500	1 000	67	60	HSK-C 63	HV-P 150 - 30000 / 26	D 36/63	HV-X 150 - 30000 / 26

Power

Chip removal processes are defined by the material being processed, tool sizes and recommended cutting speeds.

Small diameter tooling requires high speeds, while large diameter cutters need high torque at lower speeds.

The "field weakening" characteristics offer high torque at low speeds and are also capable of high spindle speeds utilizing the same spindle.

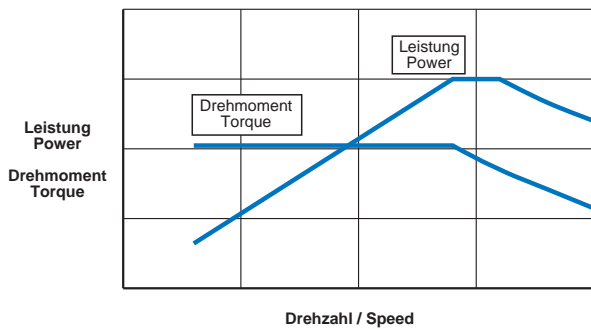

Therefore the spindles can be operated with smaller converters at different levels. The capacity of the converter determines the power profile.

The output power of the motor is produced via the converter being programmed to the proper volts/frequency [v/f] ratio specified in the instruction manual or test report of spindle.

Operation with reduced output power up to various speeds

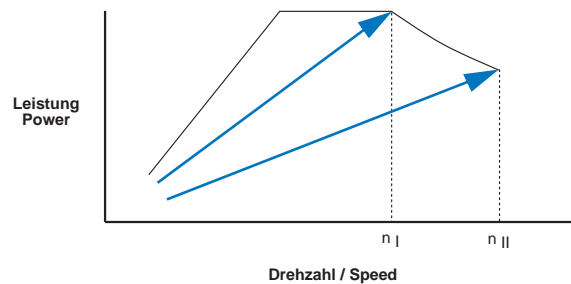

Rigidity required for the volume of material to be removed and also provide a quality finish, this demands larger shaft diameters, thereby spindles become, which allows for longer and more powerful motors.

Because of progress in the development of motors, the power density has been increased to such an extent that, in many cases, the power which can be produced from these proportions is not need for processing.

On the other hand, oversized systems cause increase costs because of the size of the frequency converter which are required.

Costs of frequency converters can be reduced by accepting the decreased output power and possibly lower frequency.

Operation mode S1 and S6-60%

Operation mode S1



Operation mode S6-60%

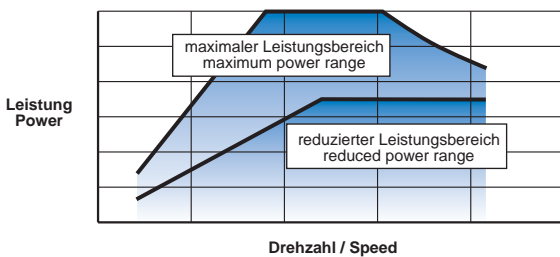
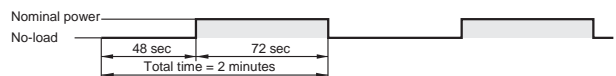

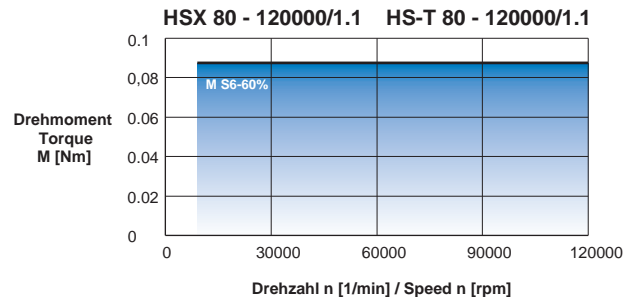
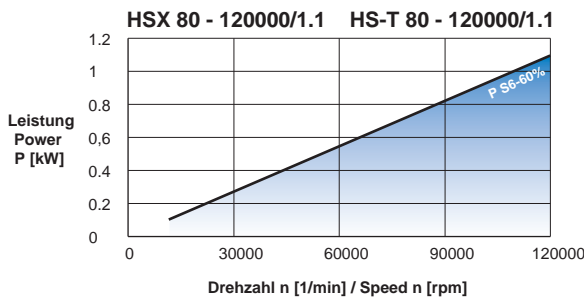
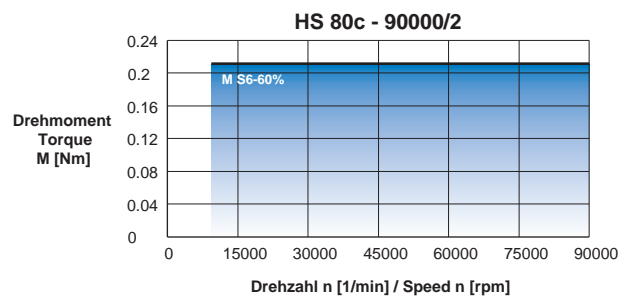
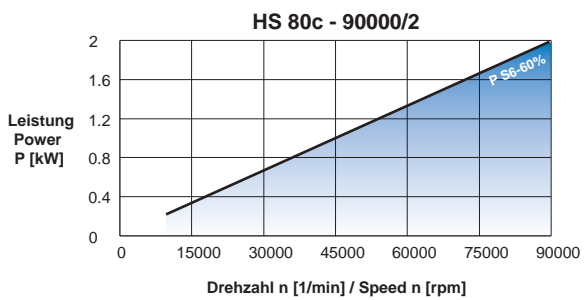
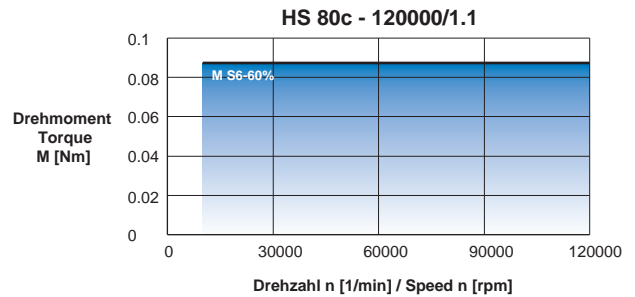
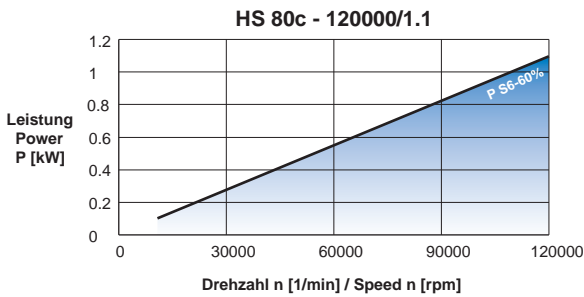
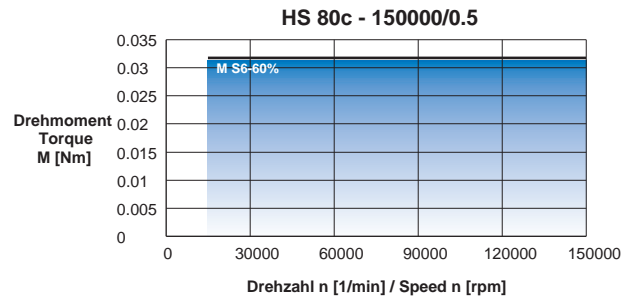
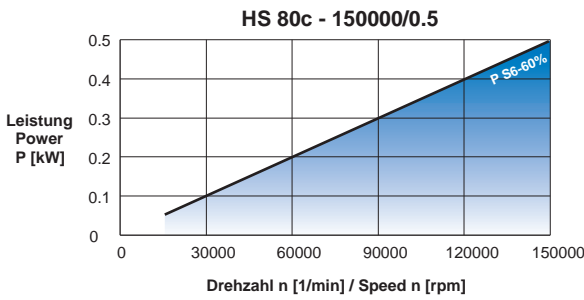
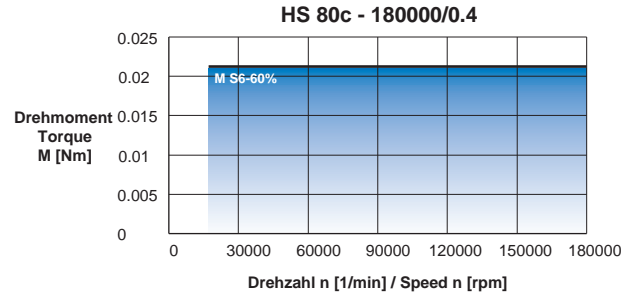
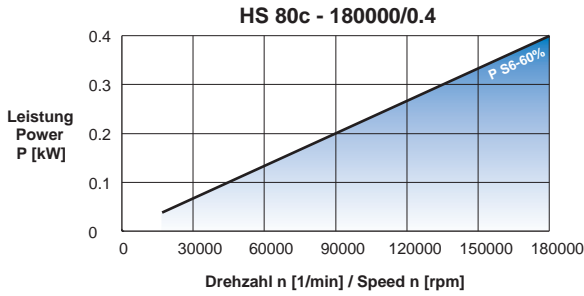

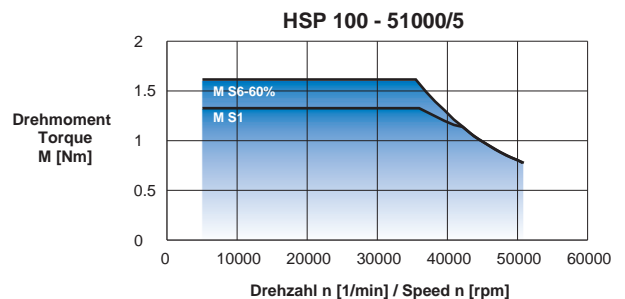
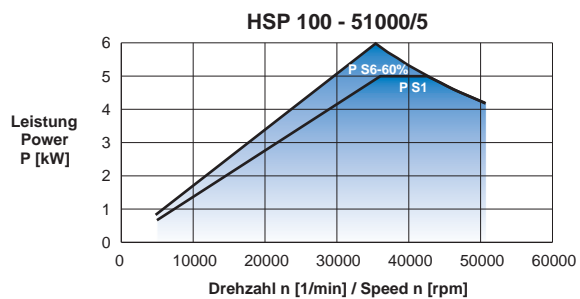
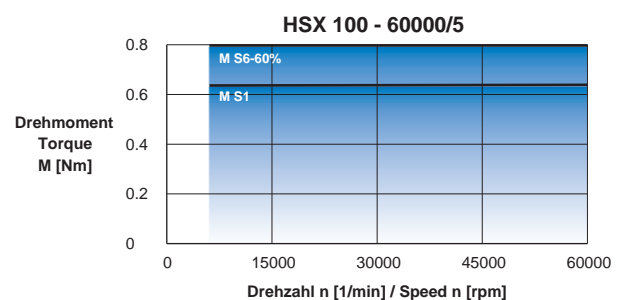
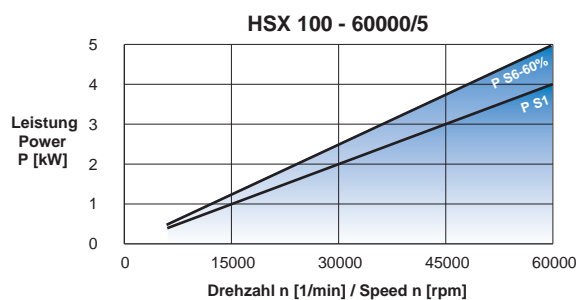
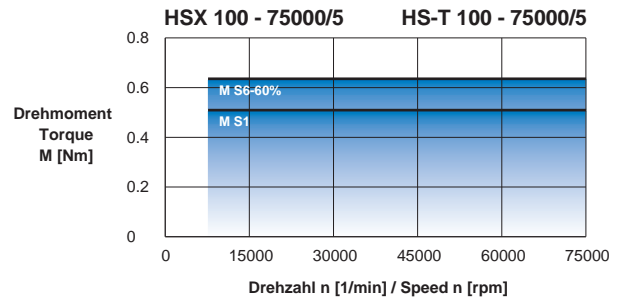
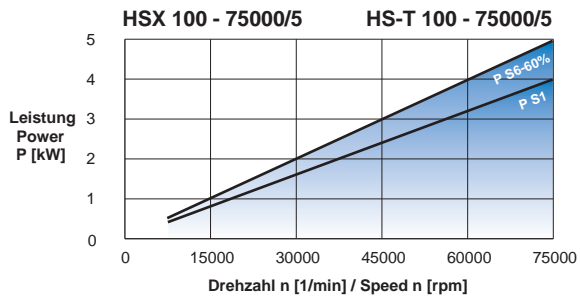
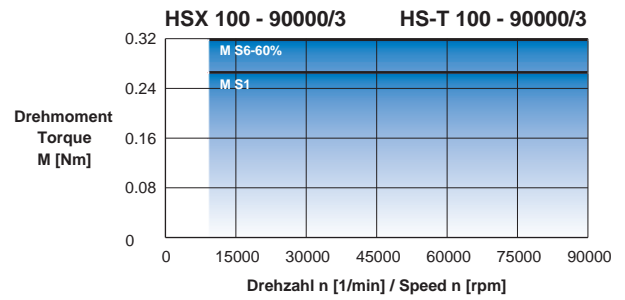
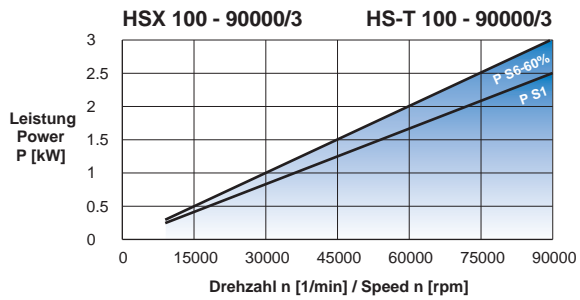
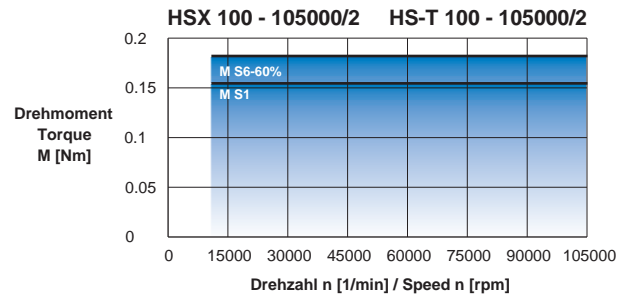
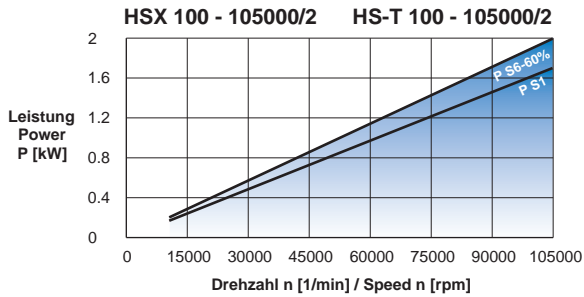

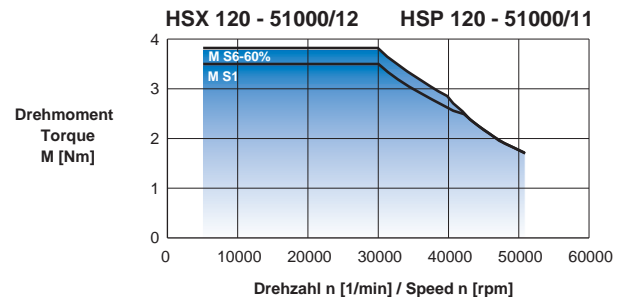
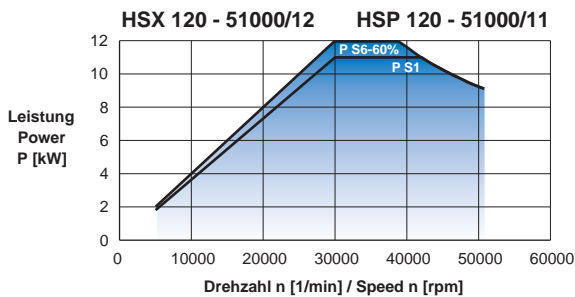
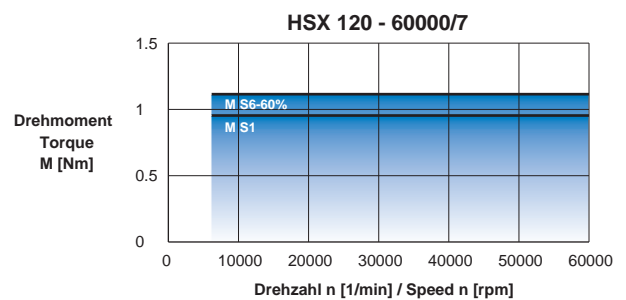
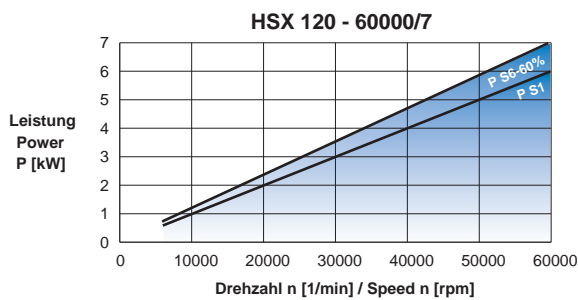
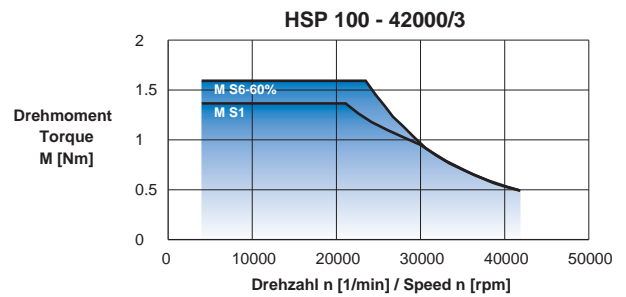
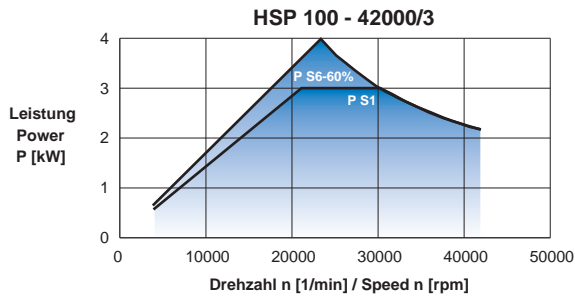
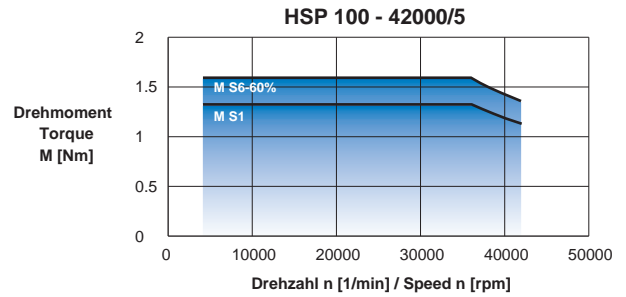
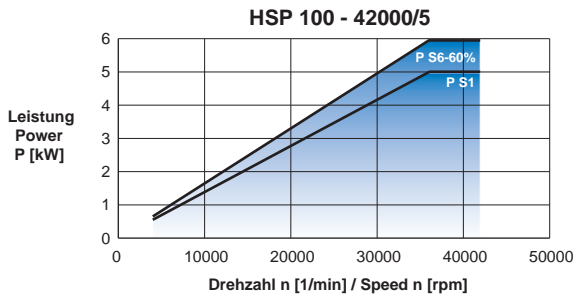
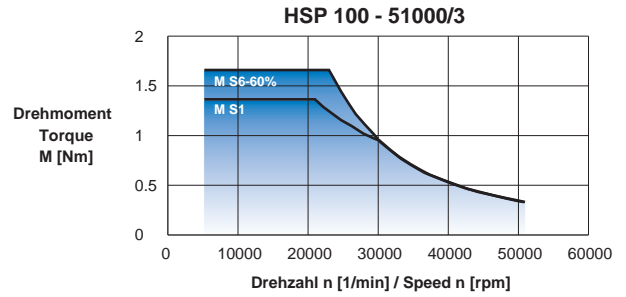
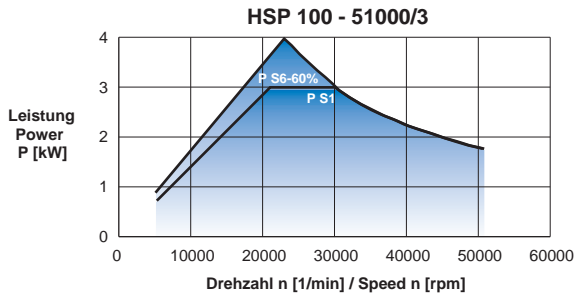

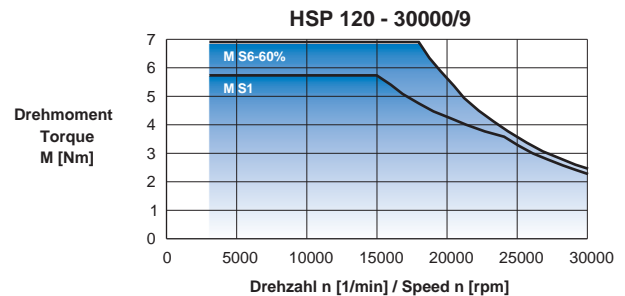
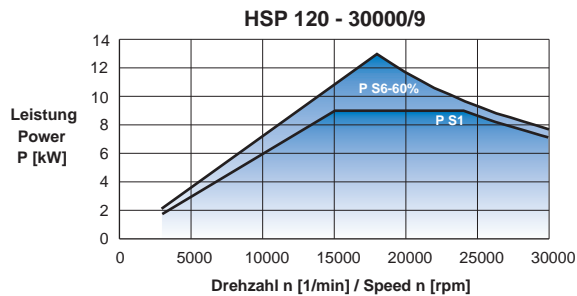
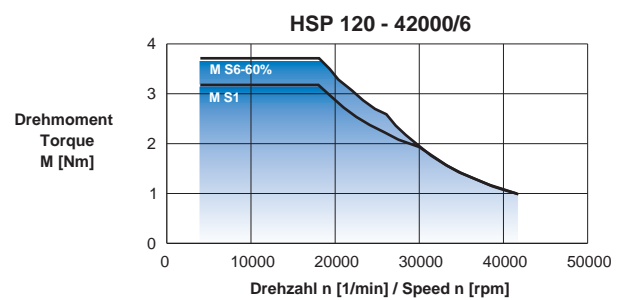
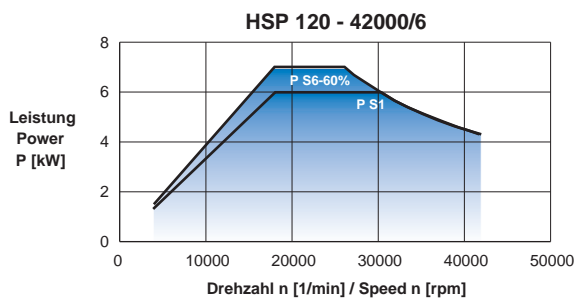
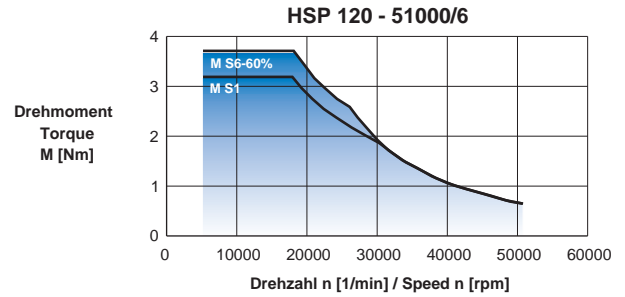
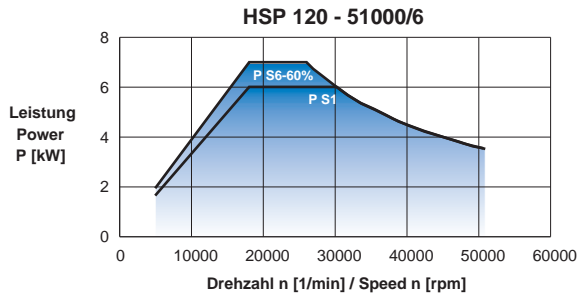
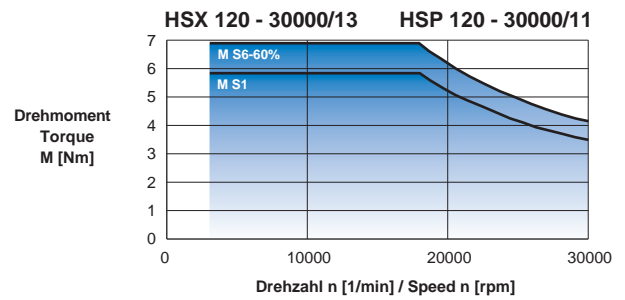
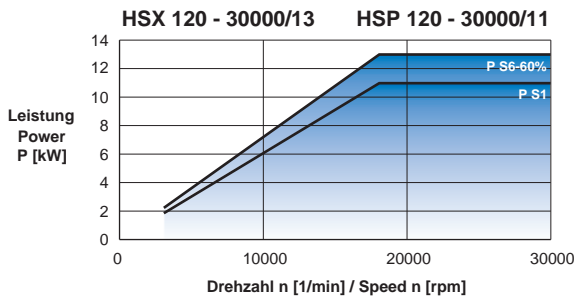
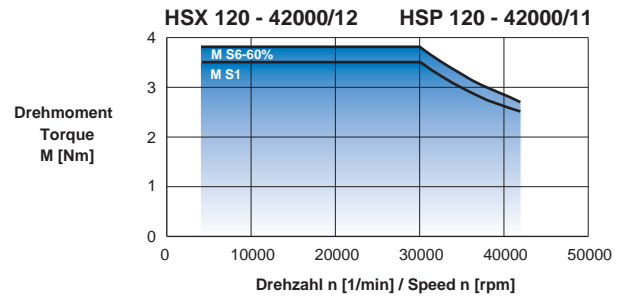
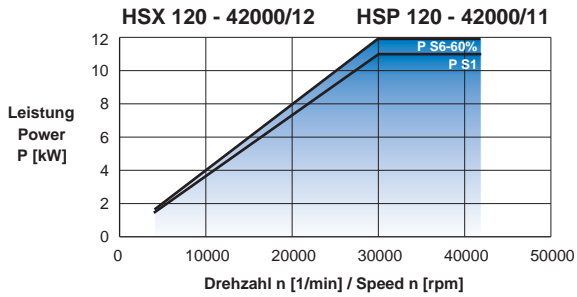

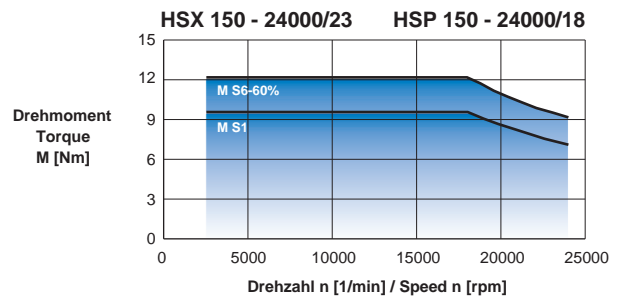
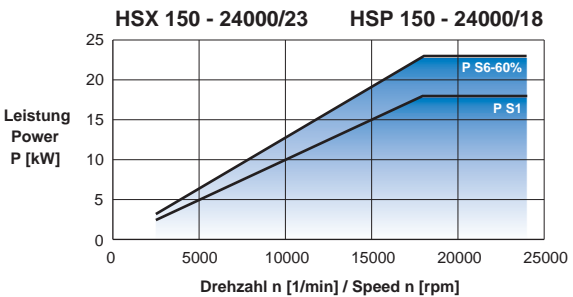
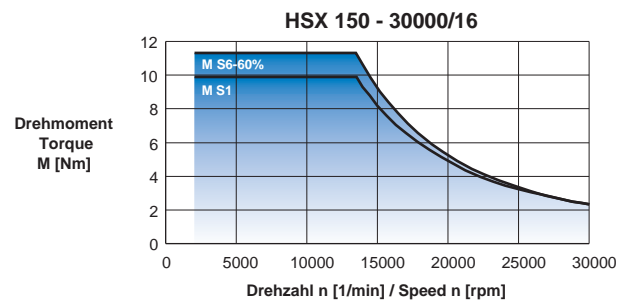
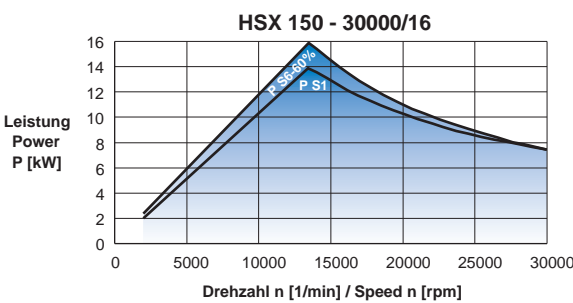
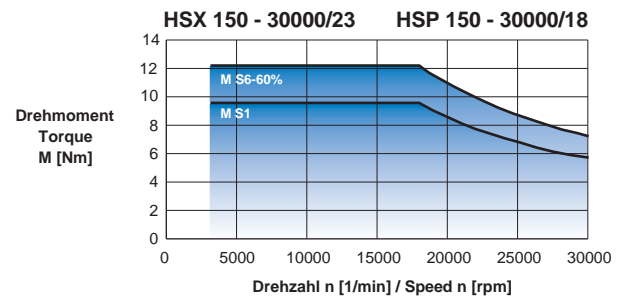
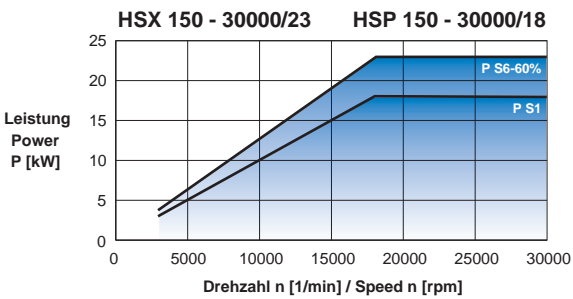
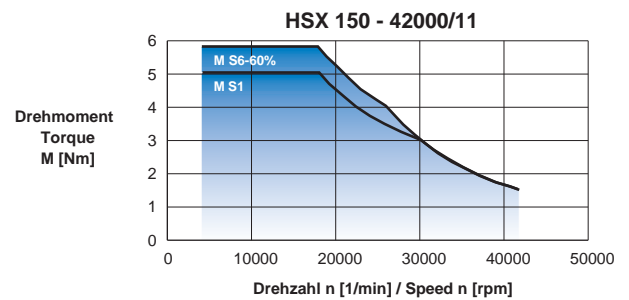
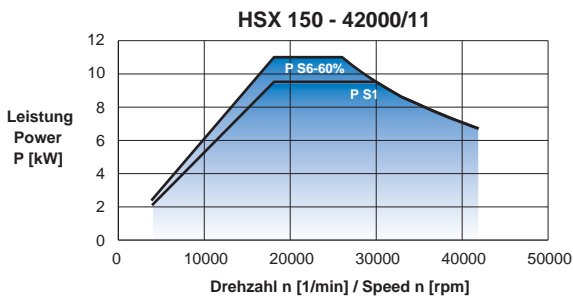
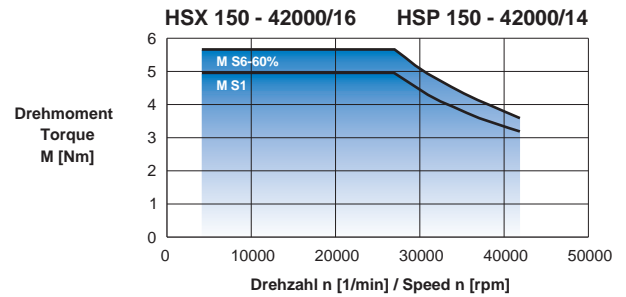
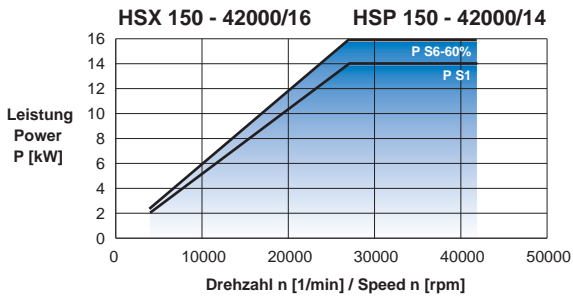

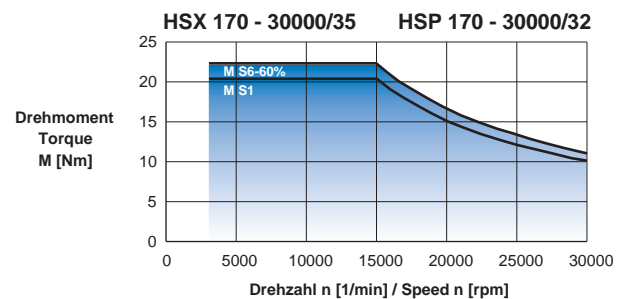
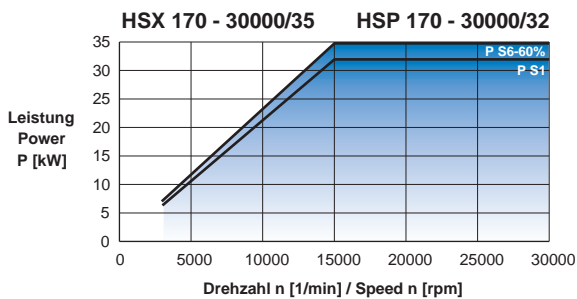
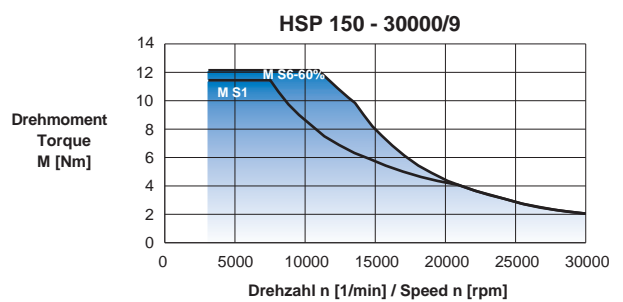
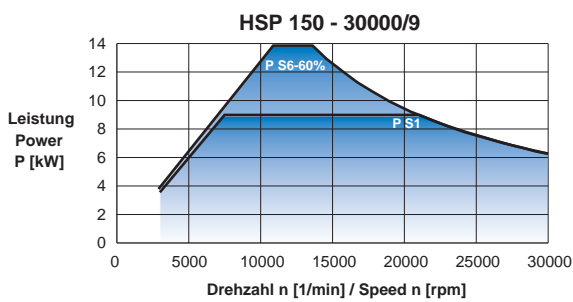
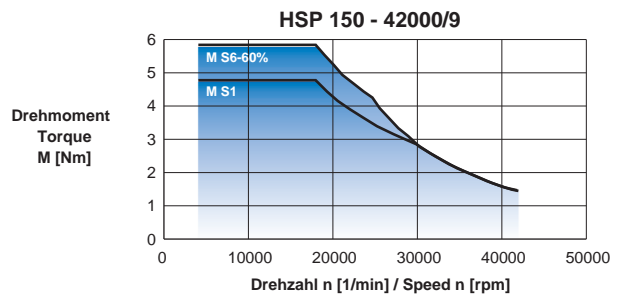
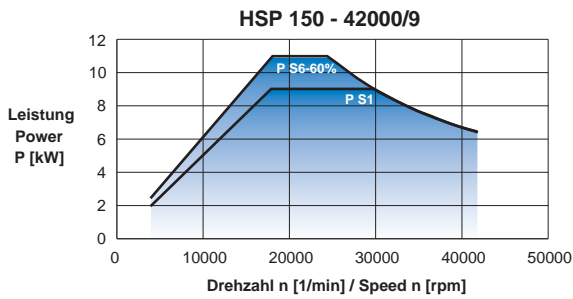
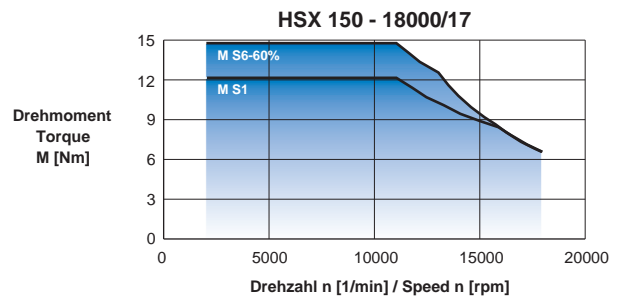
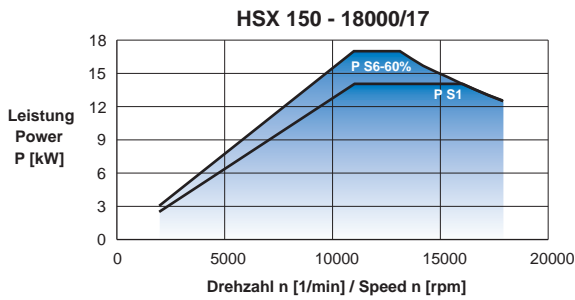
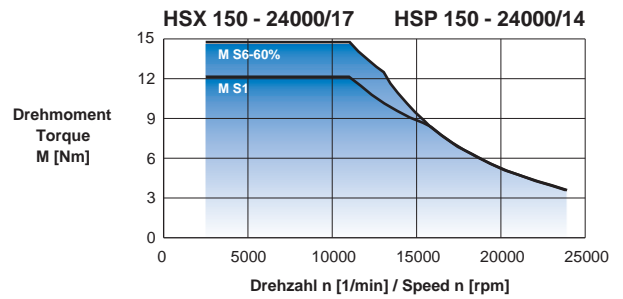
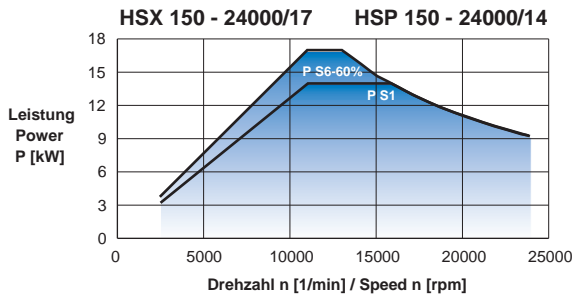

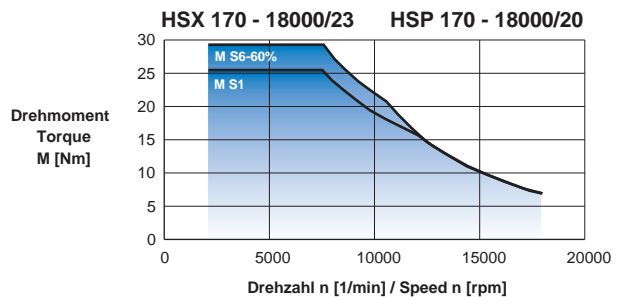
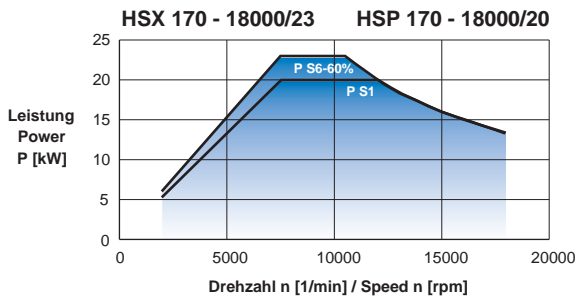
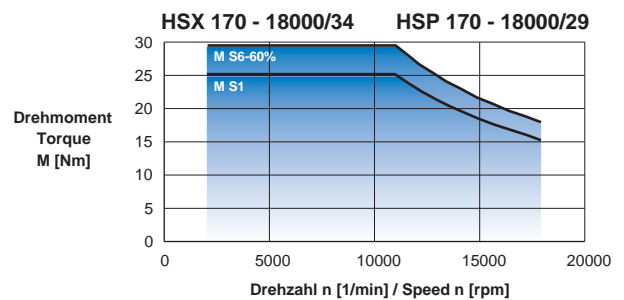
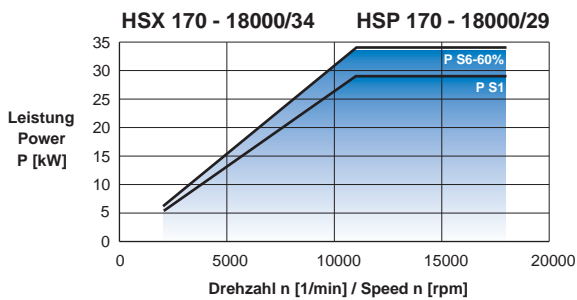
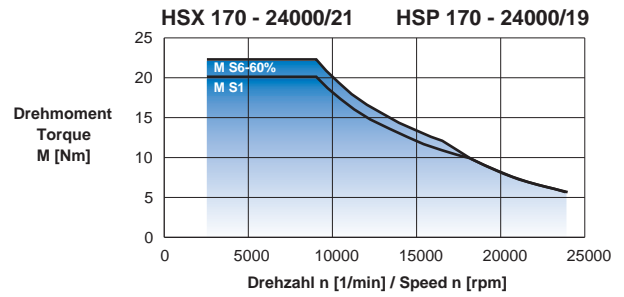
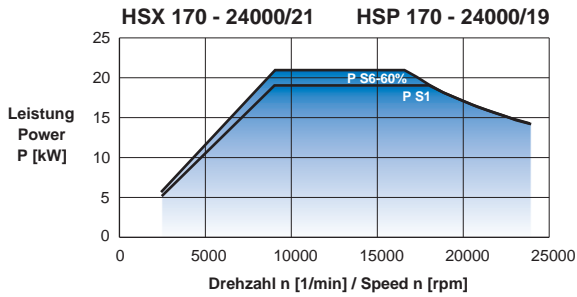
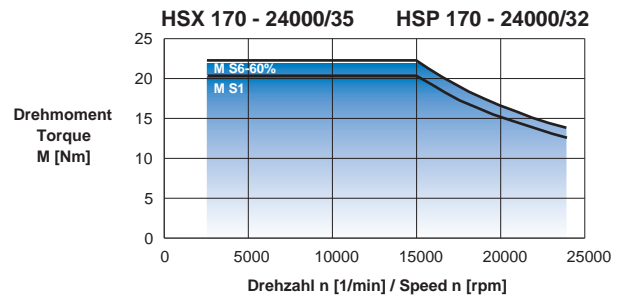
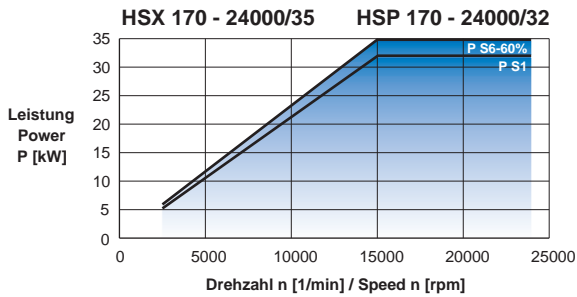
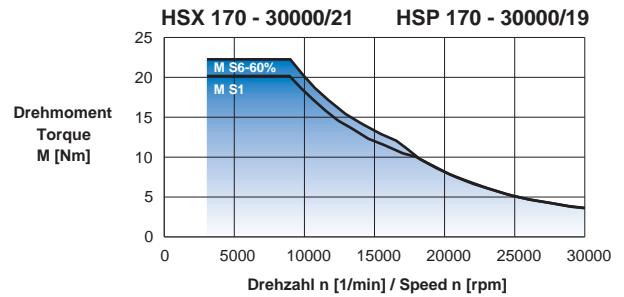
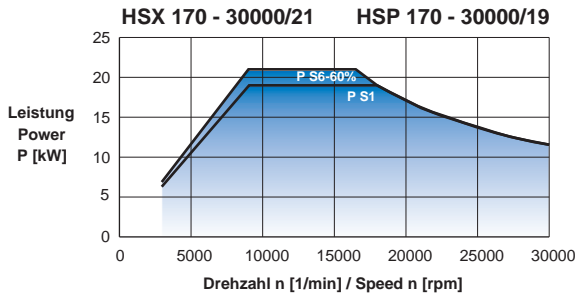

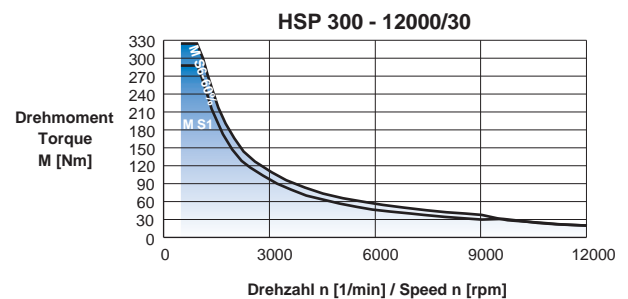
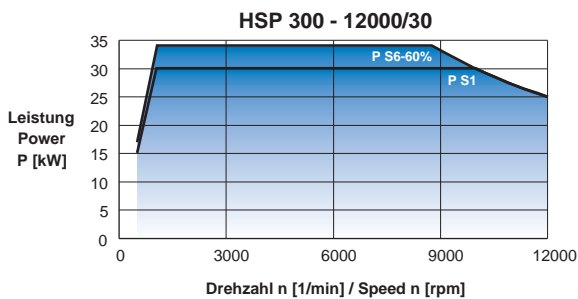
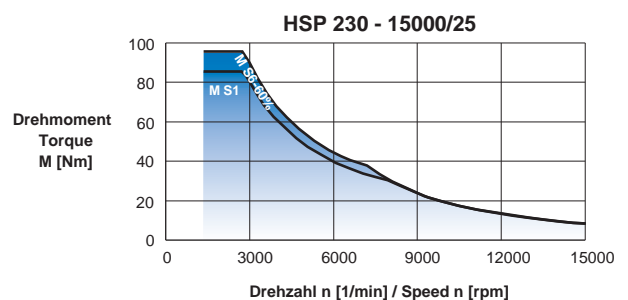
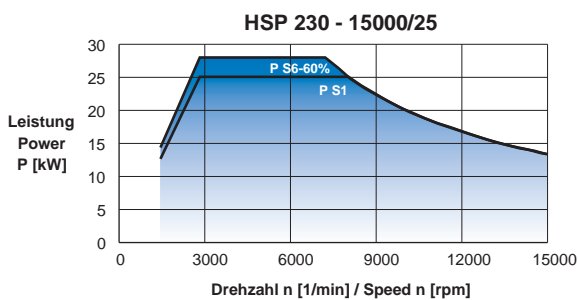
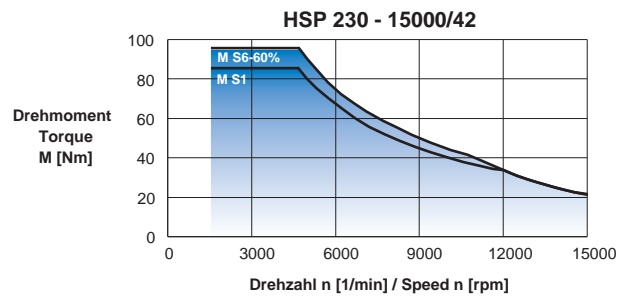
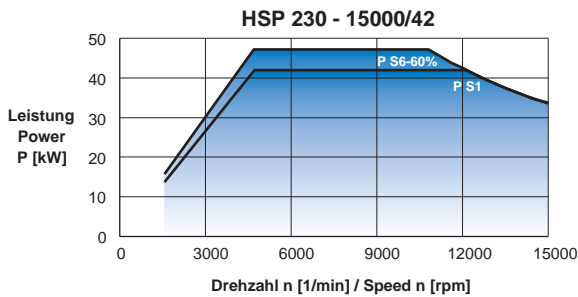
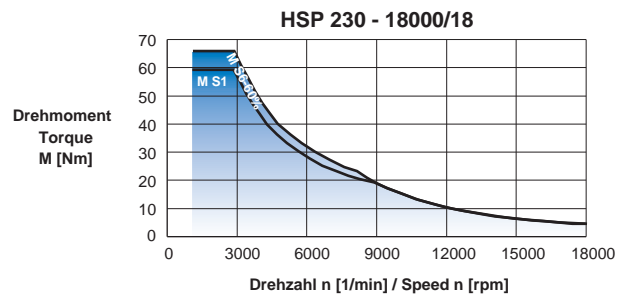
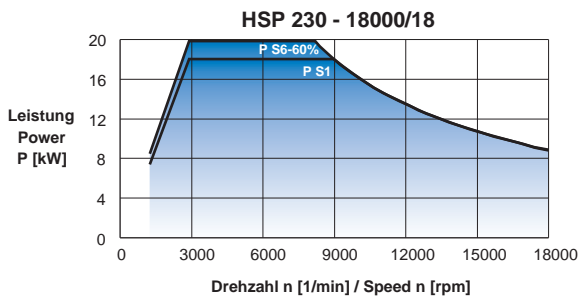
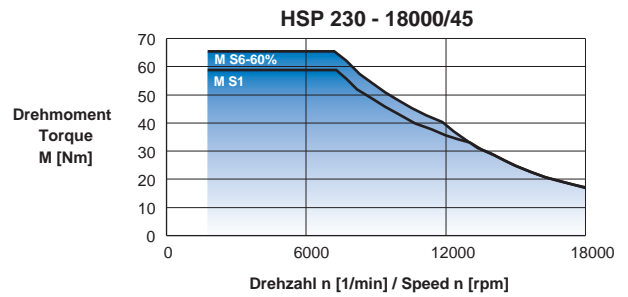
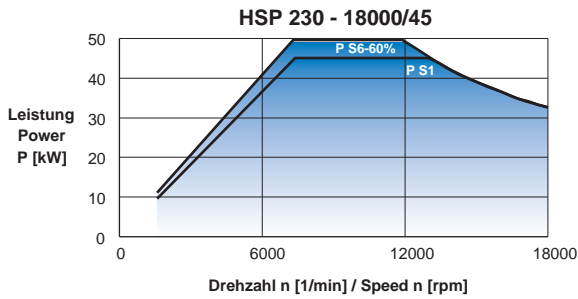

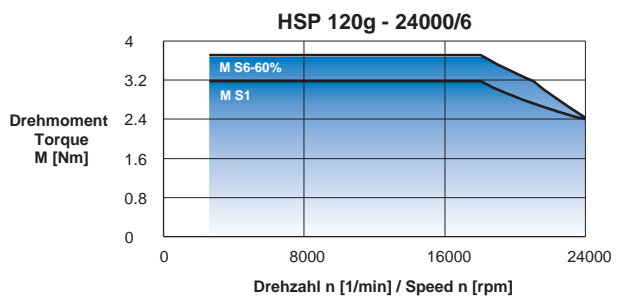
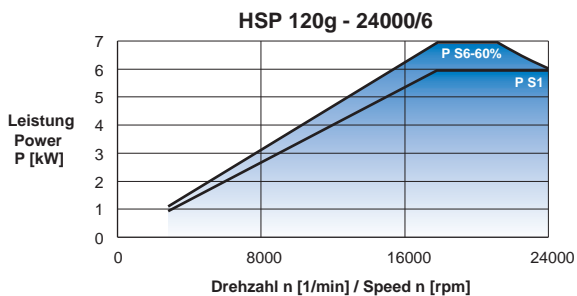
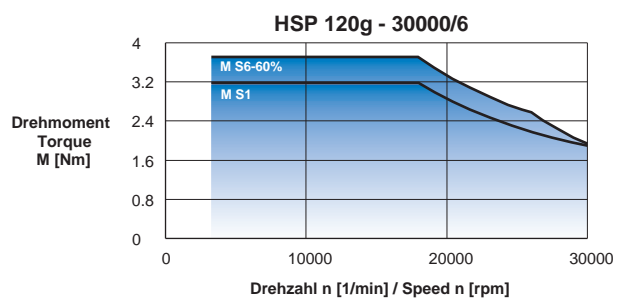
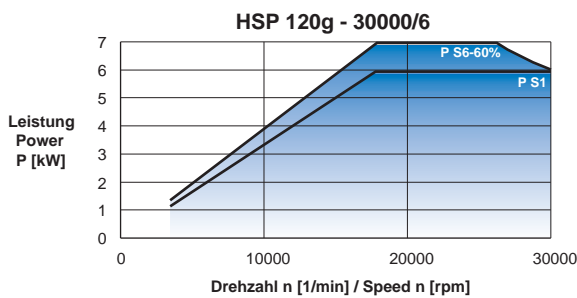
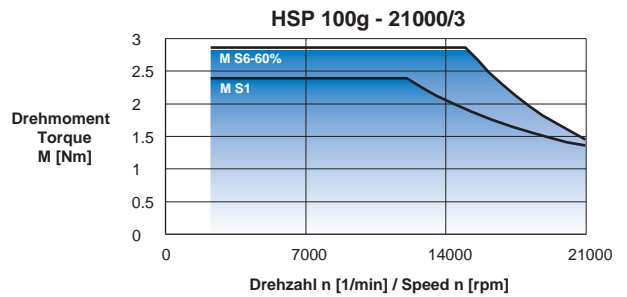
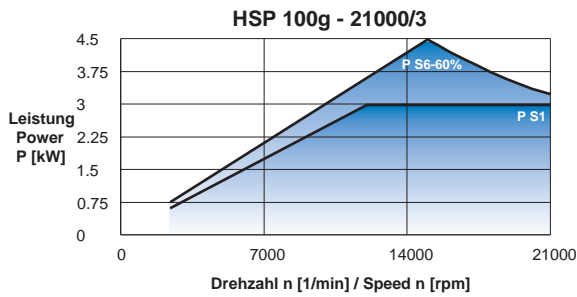
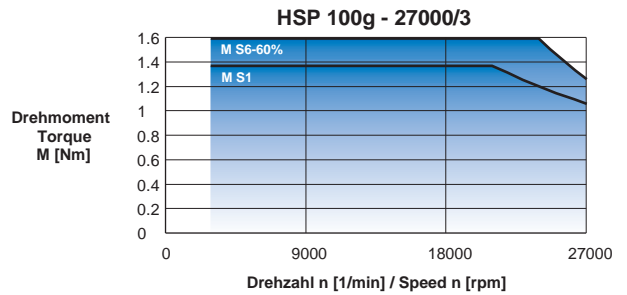
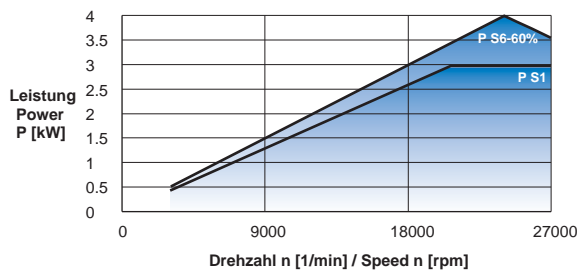
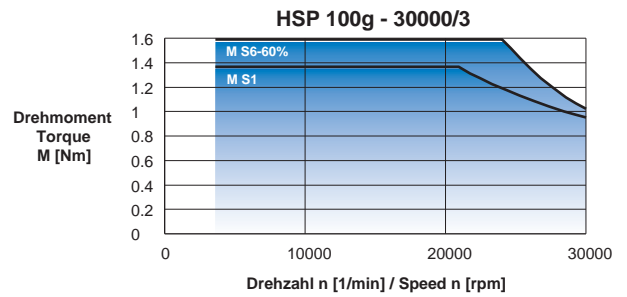
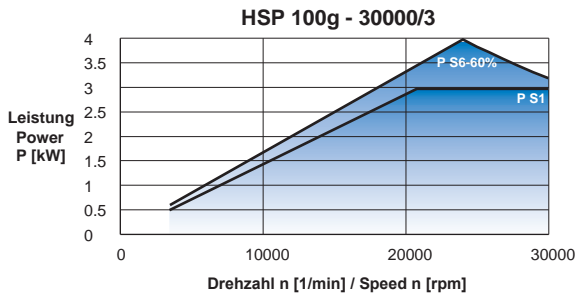

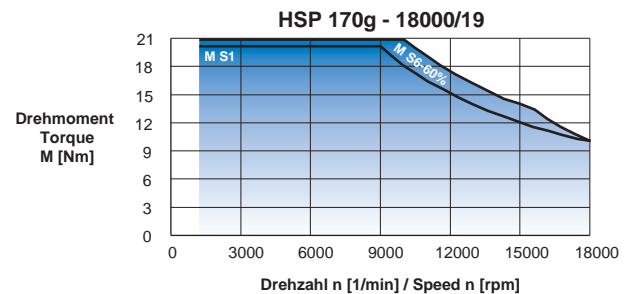
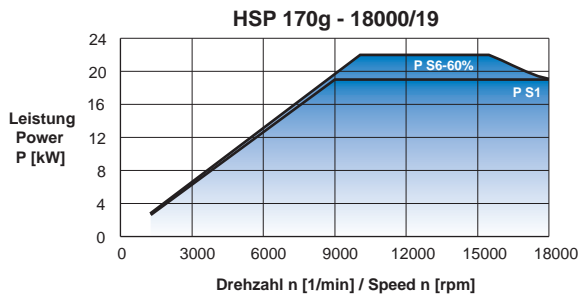
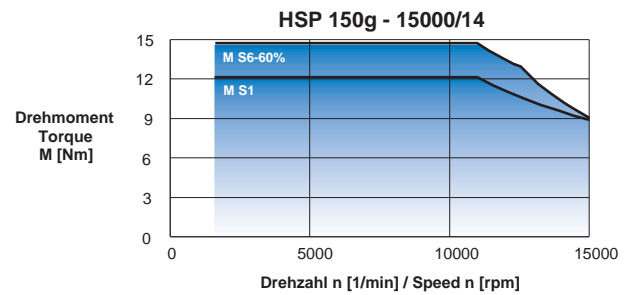
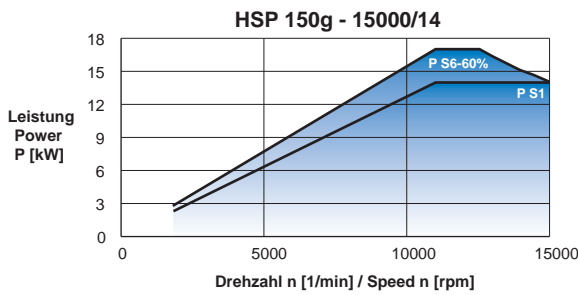
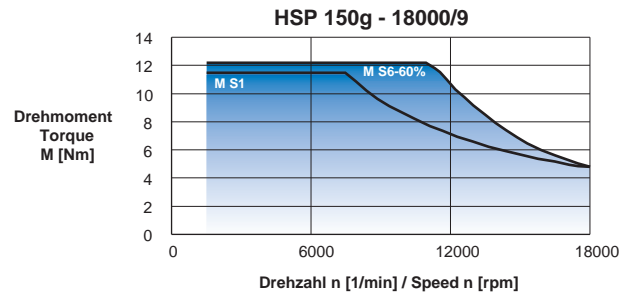
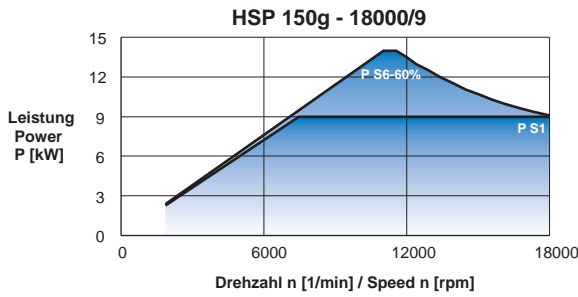
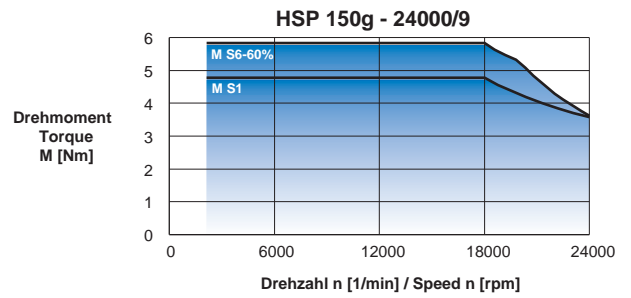
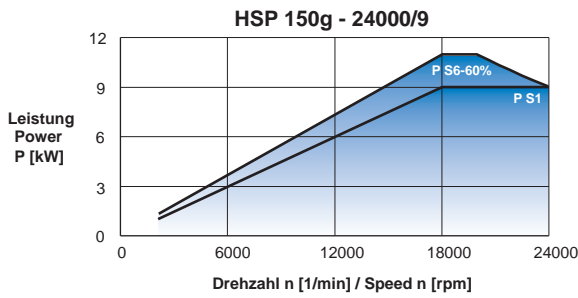
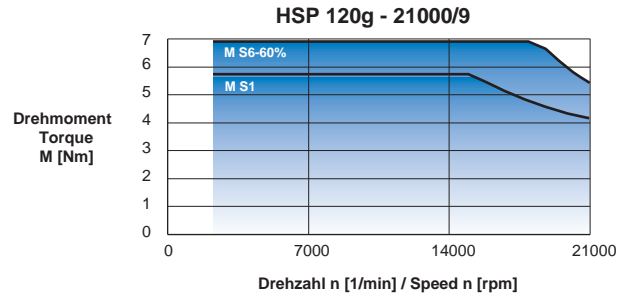
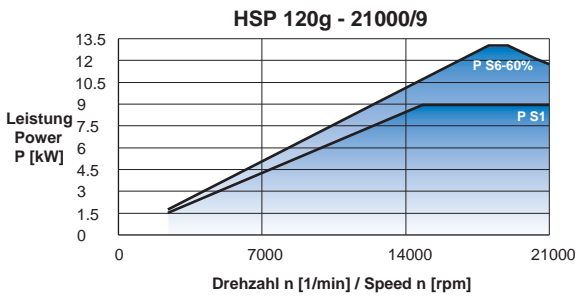

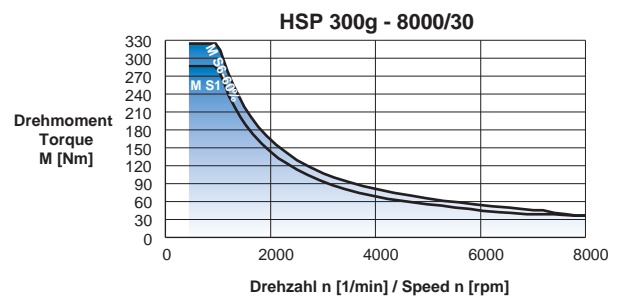
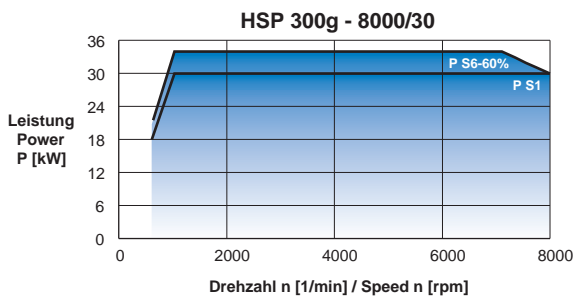
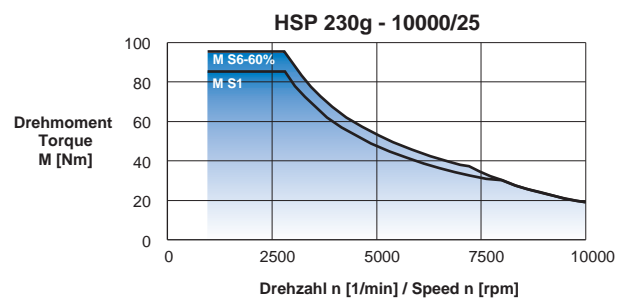
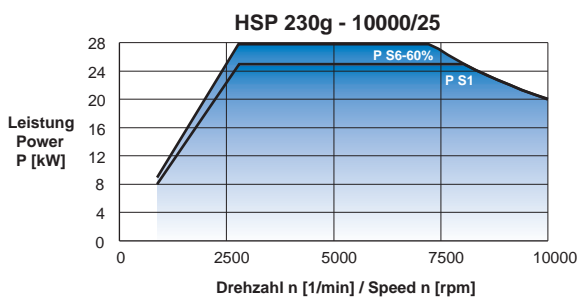
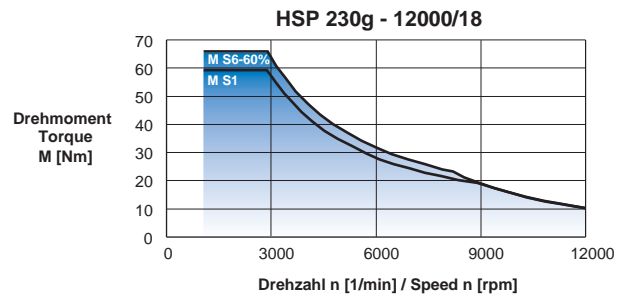
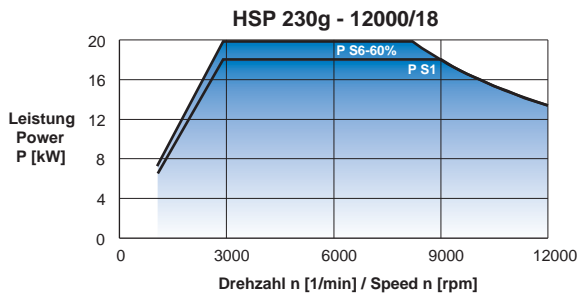
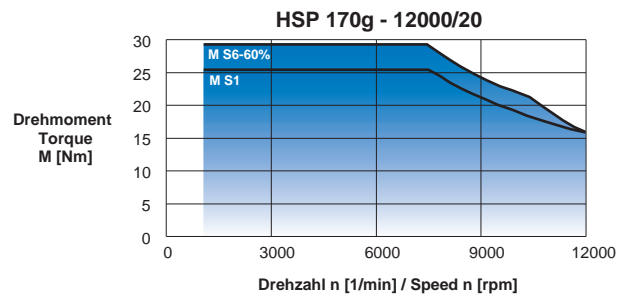
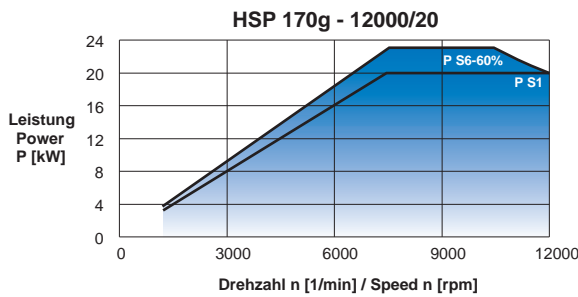
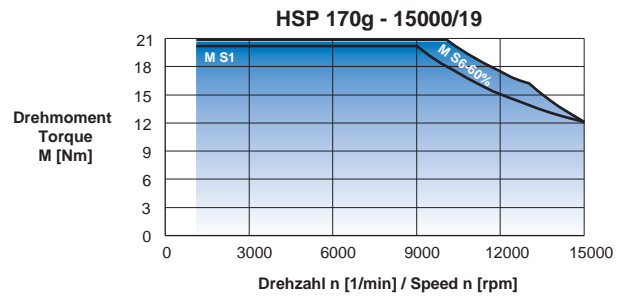
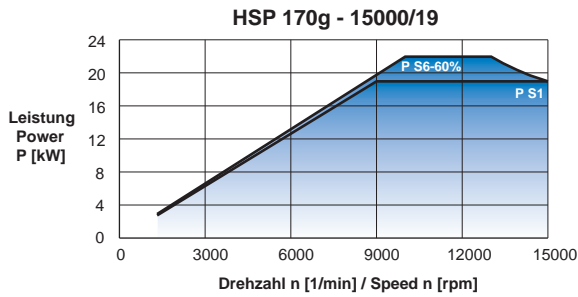

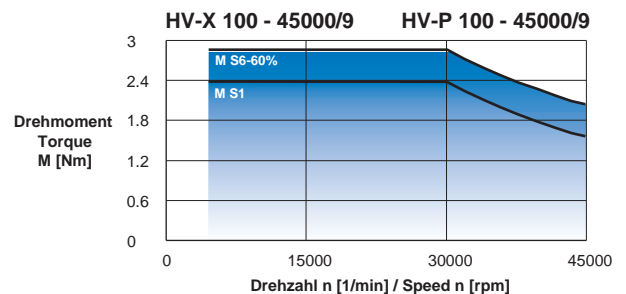
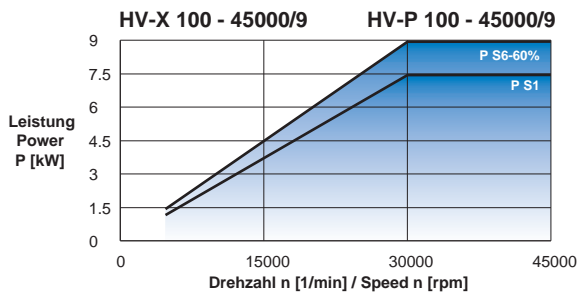
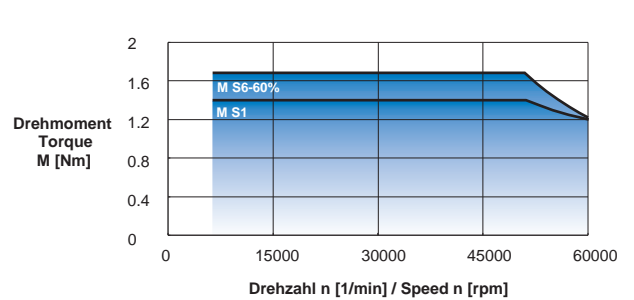
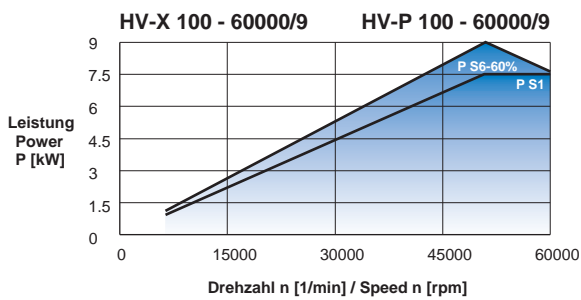
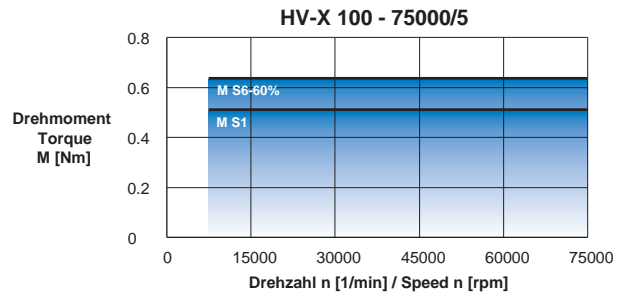
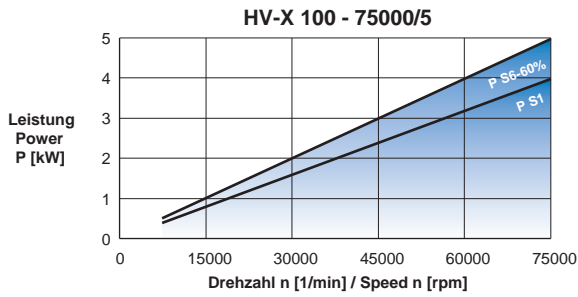
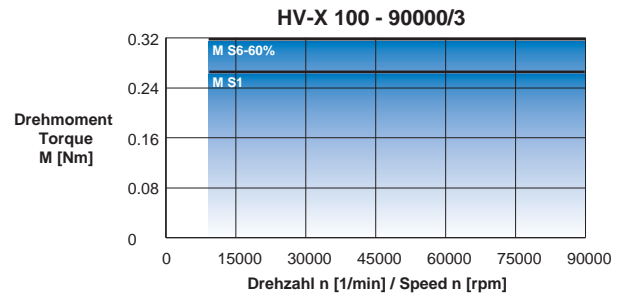
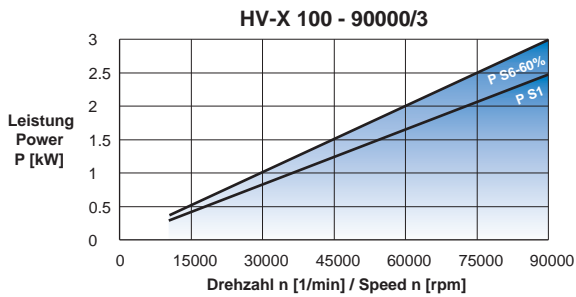
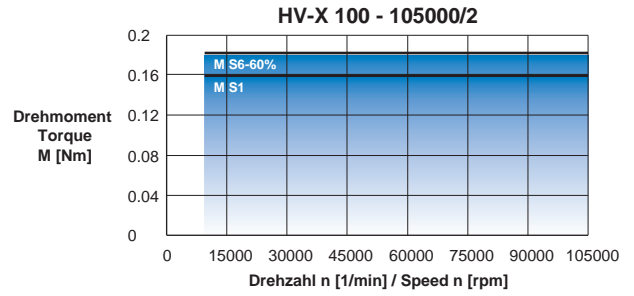
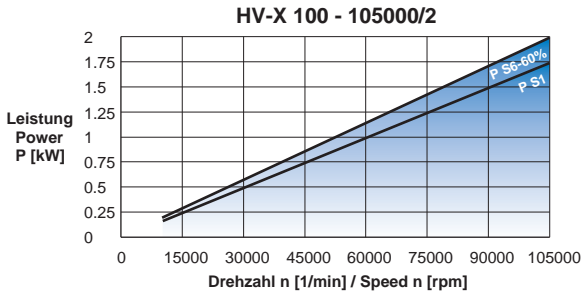

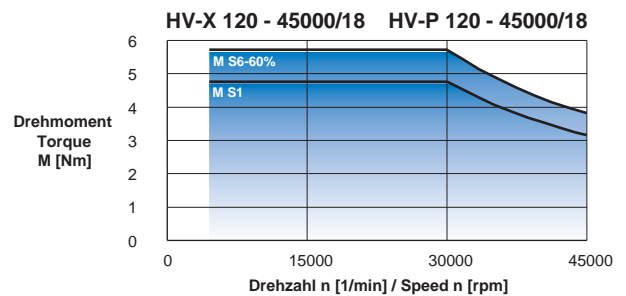
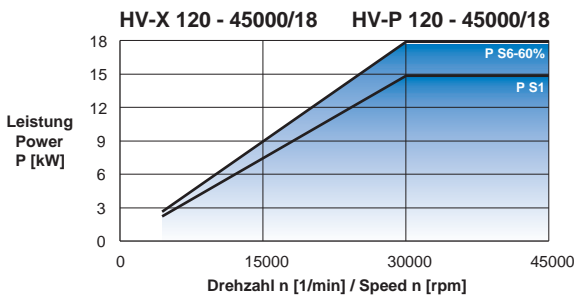
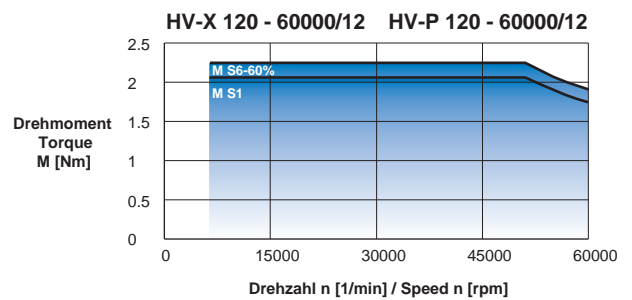
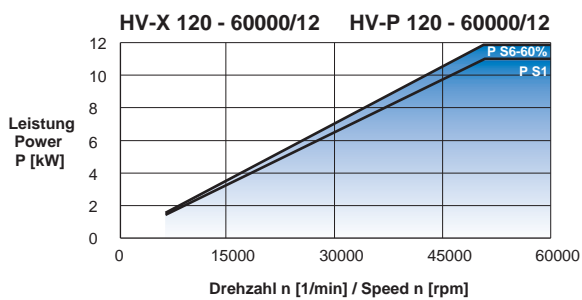
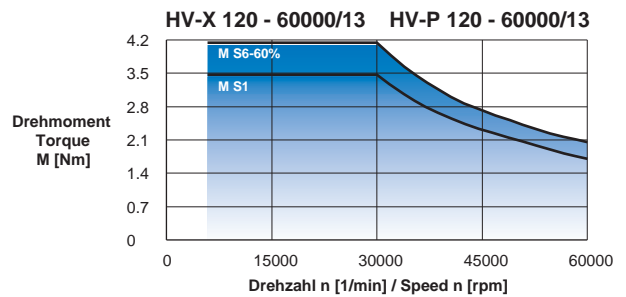
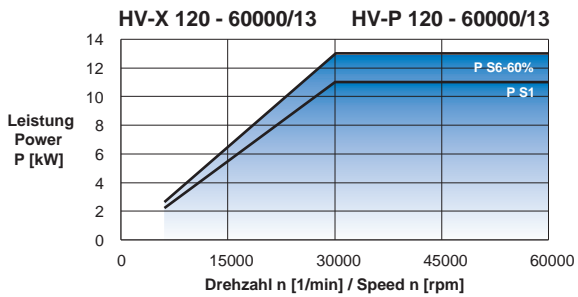
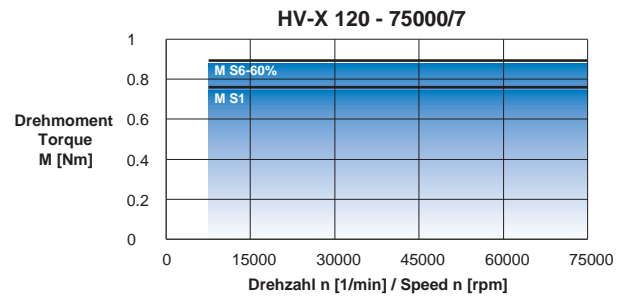
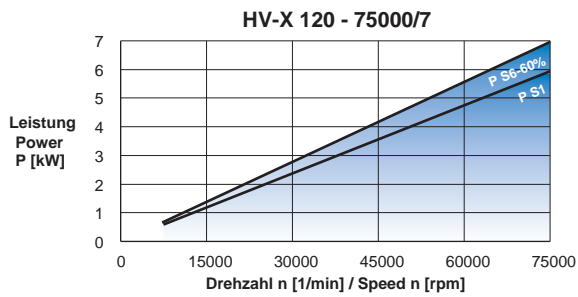
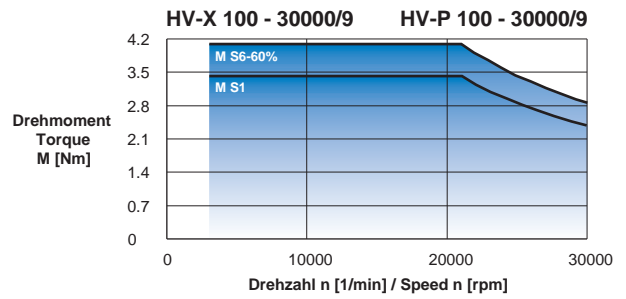
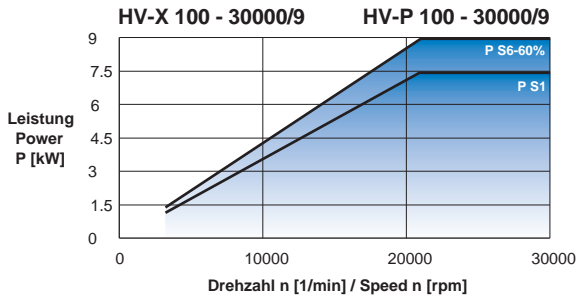

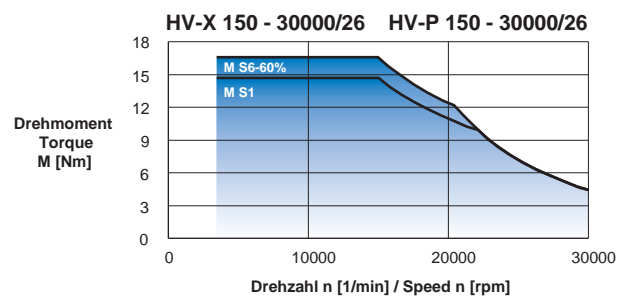
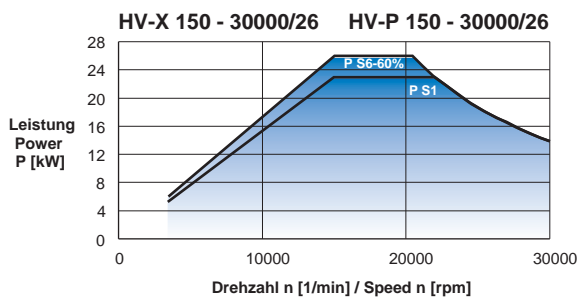
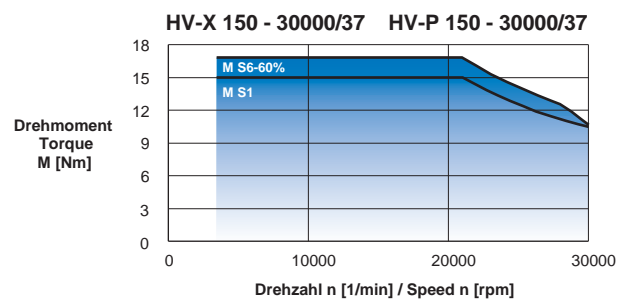
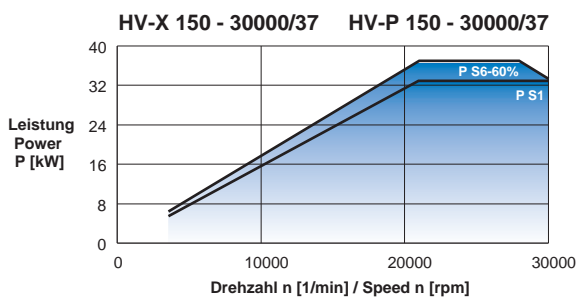
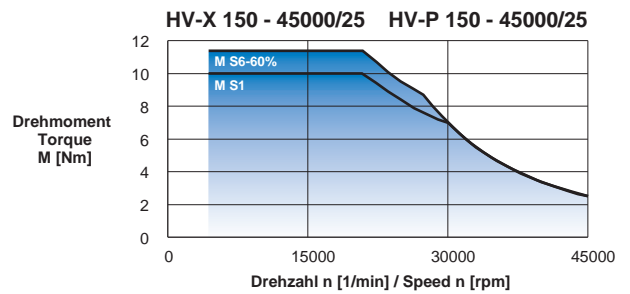
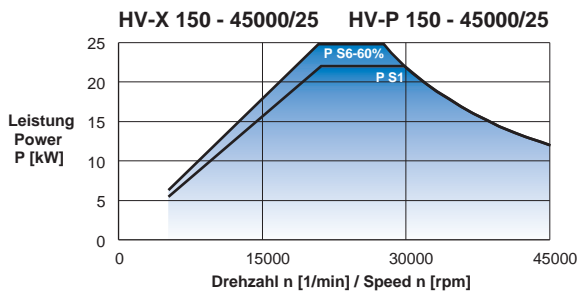
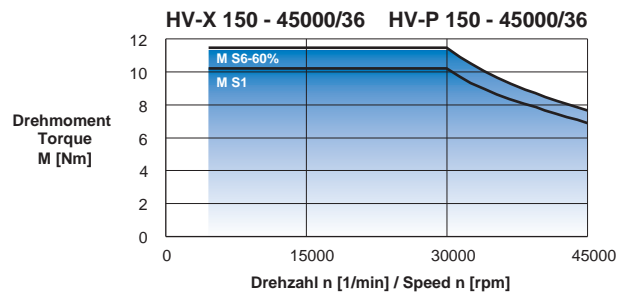
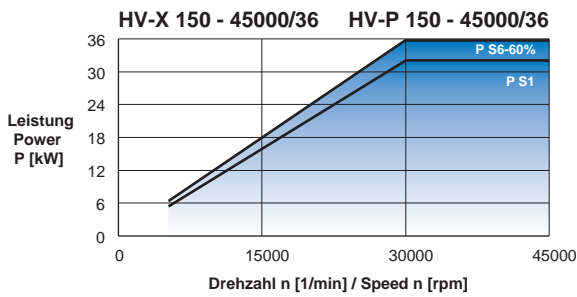
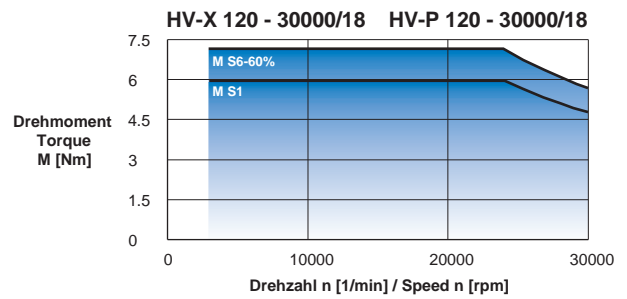
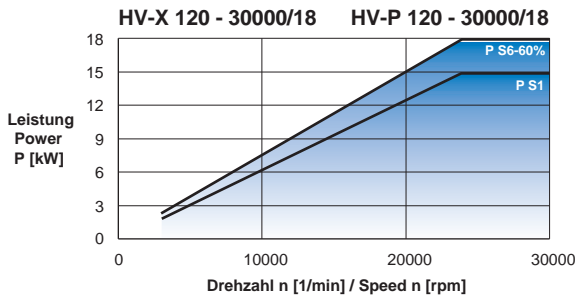

Frequency converter with Volts/Hertz characteristics

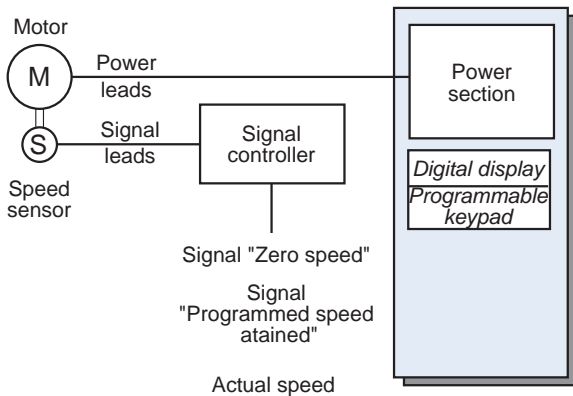

- > Output frequency's to 3000 Hertz¹⁾
- > Operating range 1 : 10
- > Acceleration/deceleration times within 10 seconds
- > Motor temperature monitoring
- > Multiple spindle operation
- > Option card for monitoring exact shaft speed and "Zero speed"
- > Option card for "Gap elimination" and "Load monitoring"

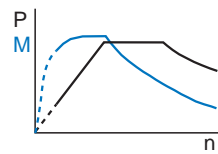

Typical power torque curve in relation to speed.

Vector control without encoder feedback

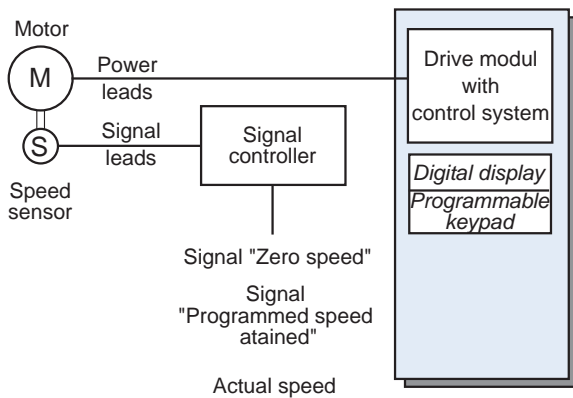

- > Output frequency's to 1400 Hertz¹⁾
- > Operating range 1 : 10 speed regulation approximately 0.5%
- > Vector controlled speed drive
- > Acceleration/deceleration within 1 second

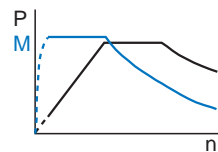

Typical power torque curve in relation to speed.

Vector control with encoder feedback

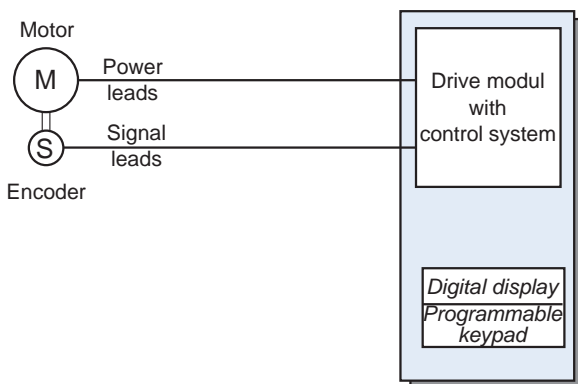

- > Output frequency's to 1400 Hz¹⁾
- > Shaft orientation
- > Acceleration/deceleration within 1 second

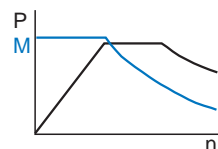

Typical power torque curve in relation to speed. Full motor torque over the entire speed range without speed fluctuation.

Tachometer TA 134

For automatized processing equipment an active signalling system is required, signalling when the processing spindle has stopped, e. g. for changing tools or protective functions.
 For this purpose a speed sensor in the spindle is required and an amplifier for signal analysis.

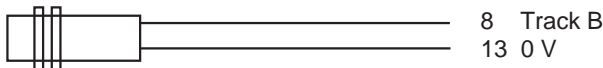
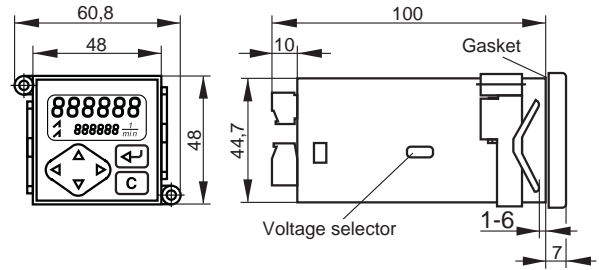

Dimensions in mm

NAMUR without explosion protection

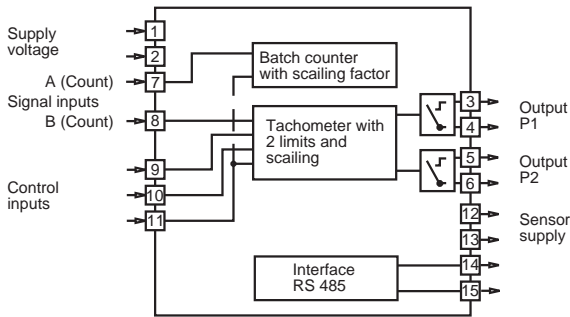

Block diagram

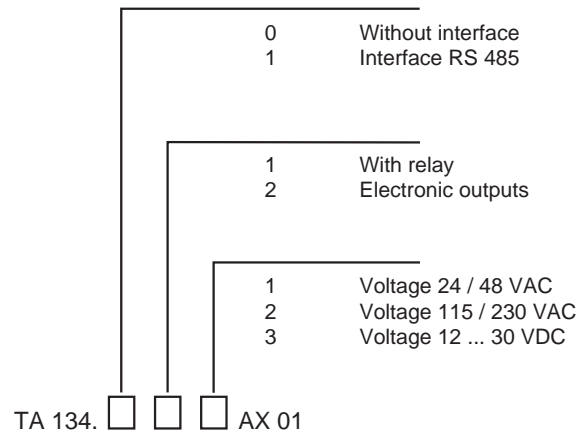

Model

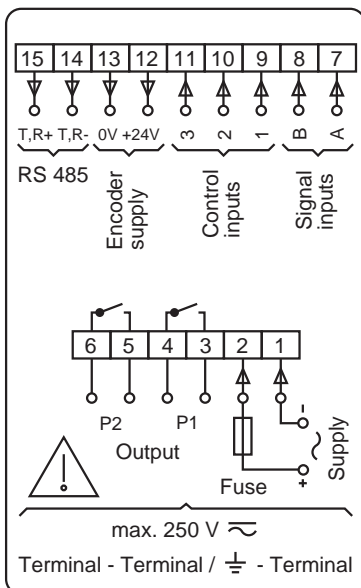

Contact	Function
1	Supply voltage
2	Supply voltage
3	Output P1
4	Output P1
5	Output P2
6	Output P2
7	Signal input A (Count)
8	Signal input B (Count)
9	Control input 1 (Tacho)
10	Control input 2 (Programming disabled)
11	Control input 3 (Batch counter Reset)
12	Encoder supply +10 ... 26 V
13	Encoder supply 0 V
14	Option RS 485 (T,R-)
15	Option RS 485 (T,R+)

Assignment

Display	7-segment LCD-display (TN) with background light On two lines
Digit size	Display of tachometer display: 7 mm Display of limit value: 4 mm
Display of measuring unit	„1/min“ „1/s“ „1/h“
Display of switching outputs P1, P2	Illustration as normally open or normally closed
Supply voltage	As ordered
Power consumption	5 VA, 4 W
Encoder supply	10 ... 26 VDC, 60 mA
Counting rate - Tachometer	25 Hz or 40 kHz
Counting rate - Batch counter	3 Hz, 25 Hz, 10 kHz
Data storage	> 10 years (via EEPROM)
Fixing	Clamping frame
Front measures	48 x 48 mm, casing for front plate installation
Mounting depth	100 mm
Connections	Two plug-in screw terminals With 6 poles (grid 5,08 mm) and with 9 poles (grid 3,81 mm)
Core cross-section	Max. 1,5 mm ²
Casing material	Makrolon 6485
Keypad	Short-stroke keys and front membrane
Front membrane	Polyester membrane
Weight	AC-model: 260 g DC-model: 140 g
Ambient temperature	0 ... +50 °C
Storage temperature	-20 ... +70 °C
Humidity	Max. relative humidity 80%, non-condensing
Protection according to DIN 40050	From the front, in built-in state with seal IP65
Operational requirements	According to contamination factor 2
General rating	EN 61010
Protection category	According to EN 61010 Protection category II
Oversvoltage category	According to EN 61010 Protection category II
Interference immunity	According to EN 50082-2 Severity grade 2-3
Emitted interference	According to EN 50081-2

Technical data

We can supply properly sized electrical power cables for connecting the spindle to the frequency inverter.

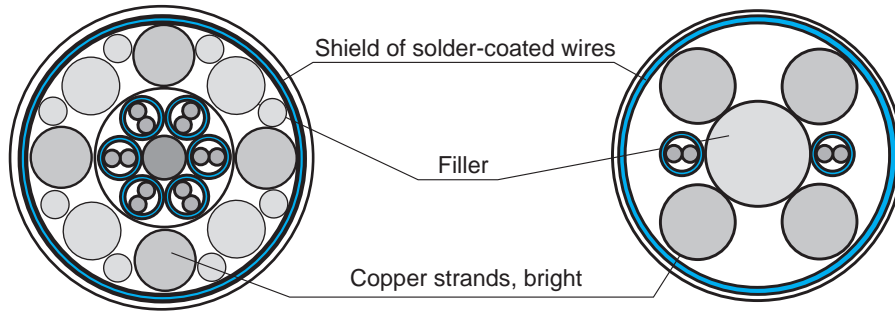

SAK 41 C

SAK 9, 24 ... 100

Type	For nominal current [A]	Power leads	Monitoring leads
SAK 9	9	Copper strands 4 x 0.75 mm ² , shielded	2 x (2 x 0.34 mm ²), shielded
SAK 18	18	Copper strands 4 x 1.5 mm ² , shielded	3 x (2 x 0.25 mm ²), shielded
SAK 24	24	Copper strands 4 x 2.5 mm ² , shielded	2 x (2 x 1.5 mm ²), shielded
SAK 33	33	Copper strands 4 x 4 mm ² , shielded	2 x (2 x 1.5 mm ²), shielded
SAK 41	41	Copper strands 4 x 6 mm ² , shielded	2 x (2 x 1.5 mm ²), shielded
SAK 41 C	41	Copper strands 4 x 6 mm ² , shielded	6 x (2 x 0.25 mm ²), shielded
SAK 55	55	Copper strands 4 x 10 mm ² , shielded	2 x (2 x 1.5 mm ²), shielded
SAK 70	70	Copper strands 4 x 16 mm ² , shielded	2 x (2 x 1.5 mm ²), shielded
SAK 80	80	Copper strands 4 x 25 mm ² , shielded	2 x (2 x 1.5 mm ²), shielded
SAK 100	100	Copper strands 4 x 35 mm ² , shielded	2 x (2 x 1.5 mm ²), shielded

Type	Sheathing	Min. bend radius stat. [mm]	Min. bend radius dyn. [mm]
SAK 9	Isolation PUR, AD 11 mm, Colour orange	45	90
SAK 18	Isolation PUR, AD 12 mm, Colour yellow	65	130
SAK 24	Isolation PUR, AD 15.5 mm, Colour orange	100	190
SAK 33	Isolation PUR, AD 15.5 mm, Colour orange	110	220
SAK 41	Isolation PUR, AD 18 mm, Colour orange	140	280
SAK 41 C	Isolation PUR, AD 20.6 mm, Colour yellow	140	280
SAK 55	Isolation PUR, AD 23 mm, Colour orange	140	280
SAK 70	Isolation PUR, AD 23.8 mm, Colour orange	145	290
SAK 80	Isolation PUR, AD 30.5 mm, Colour orange	150	300
SAK 100	Isolation PUR, AD 30.7 mm, Colour orange	170	340

In order to obtain the legal electromagnetic compatibility the cable length has to be limited. The applicable recommendations have to be met during designing and setting into operation.

Safety Aspects For Tool Selection

Unbalanced state

Every spindle shaft and every tool incorporates a degree of unbalance, which causes sinusoidal vibration during rotation. To reduce the effect of unbalancing forces, the unbalancing mass of all rotating parts has to be limited. Shafts of GMN high frequency spindles are always balanced. As a result of higher cutting speeds this process is also required for tools. We recommend for precision cutting a permissible residual unbalance for tools according to the following diagram:

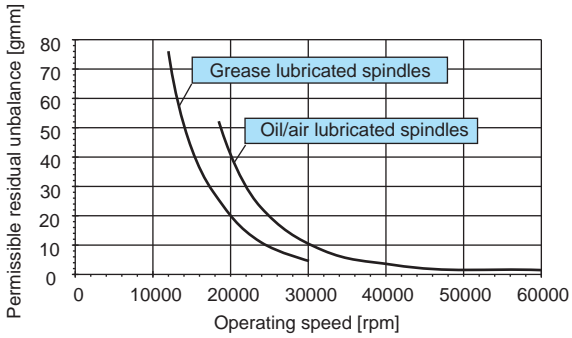

Critical speed

GMN high frequency spindles are designed so that the critical speeds remain above the maximum speed. When using inappropriate tooling the critical speed can be decreased to a level within the operating speed range. This can lead to poor part quality, decreased spindle performance, as well as jeopardizing the safety of the operator and machine.

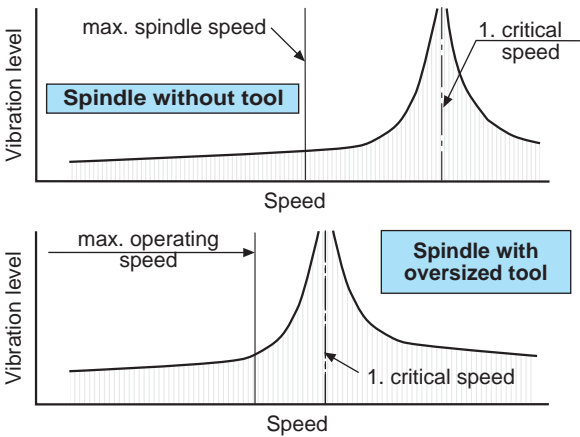

We recommend consulting our application engineering staff when tools which are extremely long and heavy are to be used.

Let GMN analyse your spindle and tooling requirements with our specifically designed computer software.

In addition to the critical frequencies the static and dynamic stiffness and load carrying capacity of each single bearing can be calculated.

Through proper analysis the correct spindle can be selected or tips for improvement of tools can be made.

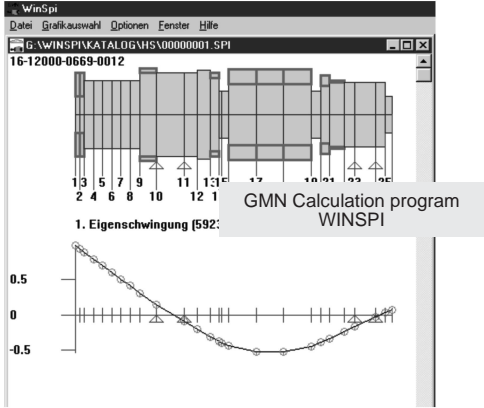

Centrifugal forces acting on tools

Centrifugal forces created by high rotating speed not only act as unbalancing forces but also induce stress into the tool. Especially inserted tooth milling cutter are very dangerous. When the attachment fails, indexable inserts can fly away like projectiles.

Vibration monitoring

Vibration monitoring equipment can lessen the risk of damage to both the spindle and machine, and also help prevent personnel injury by early detection of wear and looseness in both the spindle and tooling. When selecting and installing monitoring equipment it should be noted that vibration from the machine and related components must be filtered out or ignored, so as to prevent unnecessary shut down of the machine.

Spindle type	Surface speeds at maximum spindle speed [m/s] ¹⁾											Spindle nose			
	44	55	71										Identification	Ho	SW
HSX 100 - 105000 / ...	44	55	71										D 08/14	6	13
HS 80c - 90000 / ...	38	47	61												
HV-X 100 - 105000 / ...	44	55	71										D 09/16	6	14
HSX 100 - 90000 / ...	38	47	61	75											
HV-X 100 - 90000 / ...	38	47	61	75									D 10/18	8	16
HSX 100 - 75000 / ...		39	51	63	79										
HV-X 100 - 75000 / ...		39	51	63	79								D 14/23	8	20
HV-X 120 - 75000 / ...		39	51	63	79										
HSX 100 - 60000 / ...			41	50	63	79									
HSX 120 - 60000 / ...			41	50	63	79									
HV-X 100 - 60000 / ...			41	50	63	79							D 16/28	10	24
HV-X 120 - 60000 / ...			41	50	63	79									
HSX 120 - 51000 / ...				43	53	67	85								
HV-X 100 - 45000 / ...				37	47	59	75						D 22/38	12	32
HSX 120 - 42000 / ...					44	55	70	88							
HSX 150 - 42000 / ...					44	55	70	88							
HV-X 120 - 45000 / ...					47	59	75	94					D 28/43	12	38
HV-X 150 - 45000 / ...					47	59	75	94							
HV-X 100 - 30000 / ...						39	50	63	79						
HSX 120 - 30000 / ...						39	50	63	79						
HV-X 120 - 30000 / ...						39	50	63	79				D 32/53	12	48
HSX 150 - 30000 / ...						39	50	63	79	99					
HSX 170 - 30000 / ...						39	50	63	79	99					
HV-X 150 - 30000 / ...							50	63	79	99	125		D 36/63	15	55
HSX 150 - 24000 / ...							40	50	63	79	101				
HSX 170 - 24000 / ...							40	50	63	79	101				
HSX 150 - 18000 / ...							30	38	47	59	75				
HSX 170 - 18000 / ...								38	47	59	75	94	D 36/68	15	60

Wheel dimensions [mm]	E	8	10	13	16	20	25	32	40	50	63	80	100
	F	10	10	13	16	20	25	25	32	40	40	40	40
	G	3	3	4	6	8	10	13	16	20	25	32	36
Quill - Ø [mm]	K	5	6	8	10	13	16	20	25	32	40	50	56
Wheel mount		KI	KI	PS	PS	PS	PS	MU	MU	MU	MU	MU	MU
	see type	1	1	2+3	2+3	2+3	2+3	2+3	4	4	4	4	4
Close-fit hole attachment [mm]	d1			4	6	8	10	13					
	M1			M3	M5	M6	M8	M12					
	L5			5	7	9	12	13					
	L6			8	11	12	14	17					

Quill stiffness [N/µm]	Grinding quill diameter K [mm]	K [mm]											
		5	6	8	10	13	16	20	25	32	40	50	56
Grinding quill length H [mm]	16	4.7	9.8										
	20	2.4	5.0	15.8	38.7								
	25	1.2	2.6	8.1	19.8	56.5							
	32			3.9	9.4	27.0	61.9	151					
	40				4.8	13.8	31.7	77.3	189				
	50					7.1	16.2	39.6	96.6	259			
	63						8.1	19.8	48.3	130	317	773	1216
	80								23.6	63.3	155	378	594
	100									32.4	79.2	193	304
	125										40.5	99.0	156
	160											47.2	74.3

1) Please note: Speeds may be limited due to the critical frequency of the spindle/quill system.

Selection code:

Grinding quill [Quill-Ø K] x [Quill length H] [Spindle nose identification] [Wheel mount]
 Close-fit screw [Thread M1] - [Wheel width F]
 Clamping chuck [Key-bolt-Ø] x [Clamping length] [Spindle nose identification]

Example:

Grinding quill 20 x 63 D 22/38 PS
 Close-fit screw M12-25
 Clamping chuck 3 x 20 D 08/14

GMN Spindle nose - Standard design

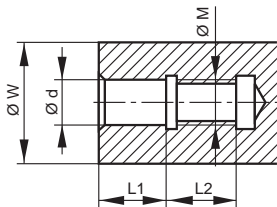

Designation	d		W [mm]	M	L1 [mm]	L2 [mm]
	[mm]	Toleranz				
D 04/08	4	+ 0.005 + 0.002	8	M4 (x 0.7)	6	8
D 06/12	6	+ 0.005 + 0.002	12	M6 (x 1)	9	11
D 08/14	8	+ 0.005 + 0.002	14	M8 (x 1.25)	12	14
D 09/16	9	+ 0.005 + 0.002	16	M9 (x 1.25)	13	14
D 10/18	10	+ 0.005 + 0.002	18	M10 (x 1.5)	15	19
D 14/23	14	+ 0.007 + 0.002	23	M14 x 1.5	20	19
D 16/28	16	+ 0.007 + 0.002	28	M16 x 1.5	24	19
D 22/38	22	+ 0.007 + 0.002	38	M22 x 2	34	25
D 22/43	22	+ 0.007 + 0.002	43	M22 x 2	34	25
D 28/43	28	+ 0.008 + 0.003	43	M28 x 2	42	25
D 32/53	32	+ 0.008 + 0.003	53	M32 x 2	46	25
D 36/63	36	+ 0.008 + 0.003	63	M36 x 2	50	30
D 36/68	36	+ 0.008 + 0.003	68	M36 x 2	50	30

GMN Clamping chuck

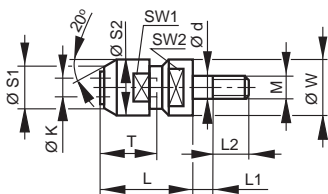

Spindle nose D [d] / [W]	Chuck K x T	L [mm]	S1 [mm]	S2 [mm]	SW 1	SW 2
D 06/12	3 x 11	14.5	7.5	10.5	9	11
D 08/14	3 x 20	26	10	14	11	13
D 09/16	3 x 20	24	10	14	11	14
D 10/18	6 x 20	28	12	18	15	14
D 10/18	6 x 20	30	12	18	15	16
D 14/23	6 x 20	30	12	18	15	20

Grinding wheel attachment (Examples)

Type 1: Cemented wheel (KI)

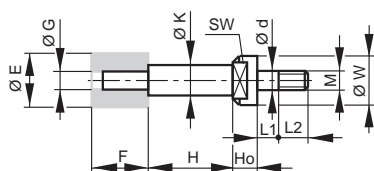

Type 4: Quill with nut (MU)

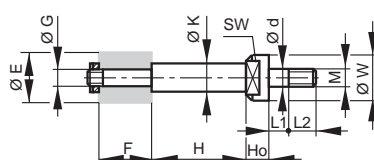

Type 2: Close-fit-screw quill (PS)

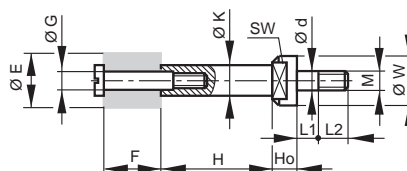

Type 3: Quill-threaded mounted points (PS)

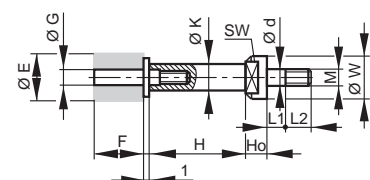

Close-fit hole for type 2 and 3

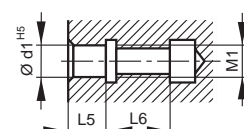

Maximum speed [rpm]					
Spindle nose identification: D 08/14		H [mm]			
Spindle type	K [mm]	< 20	25	32	
HSX 100 - 105000/...	5 and 6	105 000	105 000		
	8	105 000	105 000	90 500	
HS 80c - 90000/...	5 and 6	90 000	90 000		
	8	89 000	84 000	73 500	
Spindle nose identification: D 09/16		H [mm]			
Spindle type	K [mm]	< 20	25	32	
HV-X 100 - 105000/...	5 and 6	105 000	105 000	80 000	
	8	105 000	90 000	75 000	
	10	90 000	80 000		
HSX 100 - 90000/...	5 and 6	90 000	90 000		
	8	90 000	88 000	79 000	
	10	86 500	81 500	72 000	61 500
Spindle nose identification: D 10/18		H [mm]			
Spindle type	K [mm]	< 25	32	40	50
HV-X 100 - 90000/...	6	90 000	90 000		
	8	90 000	85 000		
	10	90 000	79 000	65 000	
	13	80 000	70 000	61 000	
HSX 100 - 75000/...	6	75 000			
	8	75 000	74 500		
	10	74 000	72 500	66 500	
	13	70 000	65 500	59 000	50 000
Spindle nose identification: D 14/23		H [mm]			
Spindle type	K [mm]	< 32	40	50	63
HV-X 120 - 75000/...	8	75 000	75 000		
	10	75 000	74 000		
	13	75 000	69 000	55 000	
	16	69 000	60 000	49 000	42 000
HV-X 100 - 75000/...	8	75 000	73 000		
	10	75 000	70 000		
	13	74 000	65 000	53 000	
	16	65 000	56 000	46 000	
HSX 120 - 60000/...	8	60 000			
	10	60 000	60 000		
	13	60 000	59 000	53 500	
	16	57 000	53 000	47 500	40 000
HSX 100 - 60000/...	8	60 000			
	10	60 000	60 000		
	13	60 000	57 500	52 000	
	16	56 000	52 000	46 500	39 500
Spindle nose identification: D 16/28		H [mm]			
Spindle type	K [mm]	< 40	50	63	
HV-X 120 - 60000/...	8	60 000	60 000		
	10	60 000	60 000		
	13	60 000	60 000		
	16	60 000	55 000	46 000	
	20	56 000	51 000	45 000	
HV-X 100 - 60000/...	8	60 000	60 000		
	10	60 000	60 000		
	13	60 000	59 000		
	16	60 000	52 000		
HSX 120 - 51000/...	10	51 000			
	13	51 000	51 000		
	16	51 000	50 000	45 000	
	20	50 500	48 500	43 000	
Spindle nose identification: D 22/38		H [mm]			
Spindle type	K [mm]	< 50	63	80	
HV-X 100 - 45000/...	10	45 000	44 000	32 000	
	13	45 000	44 000	34 000	
	16	45 000	41 000	33 000	
HSX 150 - 42000/...	13	42 000			
	16 and 20	42 000	42 000		
	25	42 000	42 000	38 000	

		Maximum speed [rpm]			
Spindle nose identification: D 22/38		H [mm]			
Spindle type	K [mm]	< 50	63	80	
HSX 120 - 42000/...	13	42 000			
	16 and 20	42 000	42 000		
	25	42 000	42 000	36 000	
Spindle nose identification: D 28/43		H [mm]			
Spindle type	K [mm]	< 63	80	100	
HV-X 150 - 45000/...	13	45 000			
	16 and 20	45 000			
	25	45 000	40 000		
	32	42 000	36 000	30 000	
HV-X 120 - 45000/...	13	45 000			
	16 and 20	45 000			
	25	45 000	38 000		
HSX 120 - 30000/...	16 and 20	30 000			
	25	30 000	30 000		
	32	30 000	29 000	25 000	
HV-X 100 - 30000/...	16	30 000	30 000	25 000	
	20	30 000	30 000	24 000	
	25	30 000	26 000	21 000	
Spindle nose identification: D 32/53		H [mm]			
Spindle type	K [mm]	< 63	80	100	125
HSX 170 - 30000/...	16 and 20	30 000			
	25	30 000	30 000		
	32	30 000	30 000	30 000	
	40	30 000	30 000	28 000	23 500
HSX 150 - 30000/...	16 and 20	30 000			
	25	30 000	30 000		
	32	30 000	30 000	27 500	
	40	30 000	28 000	25 000	21 500
HV-X 120 - 30000/...	16 and 20	30 000			
	25	30 000	30 000		
	32	30 000	30 000		
	40	30 000	28 000		
Spindle nose identification: D 36/63		H [mm]			
Spindle type	K [mm]	< 80	100	125	160
HV-X 150 - 30000/...	20 and 25	30 000			
	32	30 000	30 000		
	40	30 000	27 000	21 000	
	50	30 000	24 000	18 000	15 000
HSX 170 - 24000/...	20 and 25	24 000			
	32	24 000	24 000		
	40	24 000	24 000	23 000	
	50	24 000	24 000	20 500	17 000
HSX 150 - 24000/...	20 and 25	24 000			
	32	24 000	24 000		
	40	24 000	24 000	21 500	
	50	24 000	21 500	18 500	15 500
HSX 150 - 18000/...	20 and 25	18 000			
	32	18 000	18 000		
	40	18 000	18 000	18 000	
	50	18 000	18 000	18 000	16 500
Spindle nose identification: D 36/68		H [mm]			
Spindle type	K [mm]	< 80	100	125	160
HSX 170 - 18000/...	25	18 000			
	32	18 000	18 000		
	40	18 000	18 000	18 000	
	50 and 56	18 000	18 000	18 000	18 000

Shrink Fit Tool Holders

High speed machining requires tooling which is rigid, accurate, balanced and also economical. Shrink fit type tool holder systems have been used successfully in high production machining centers applications with HSK and Milling Machine Tapers. As a result of proven advantages of the shrink fit method, GMN has developed a manual change style holder design.

Clamping method

There are several heat shrinking systems available. The most economical for the manual type tool holders is the „HOT AIR“ method.

Dimensions

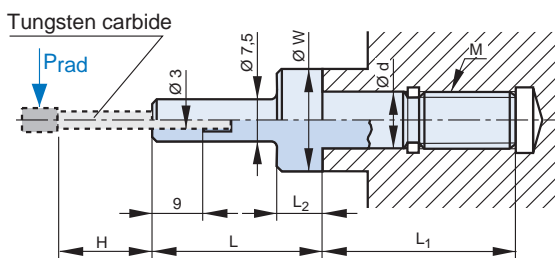

Spindle type	L [mm]	L ₁ [mm]	L ₂ [mm]	d [mm]	W [mm]	M [mm]
HS 80c-180000 / 0,4	14	14	4	4	8	M4
HS 80c-150000 / 0,5						
HS 80c-120000 / 1,1	14,5	20	5	6	12	M6
HSX 100-105000 / 2	26	26	6	8	14	M8
HS 80c- 90000 / 2						
HSX 100- 90000 / 3	24	27	6	9	16	M9
HSX 80-120000 / 1,1						
HSX 100- 75000 / 5	30	34	8	10	18	M10
HSX 100- 60000 / 5	30	39	8	14	23	M14 x1,5
HSX 120- 60000 / 7						

Ordering information: Shrink fit holder d / W x 3

Ex. HSX 100-75000/5: d (10) / W (18) x 3.

The „3“ indicates the clamping diameter. The standard and smallest clamping diameter is 3 mm. Larger diameters are available upon request.

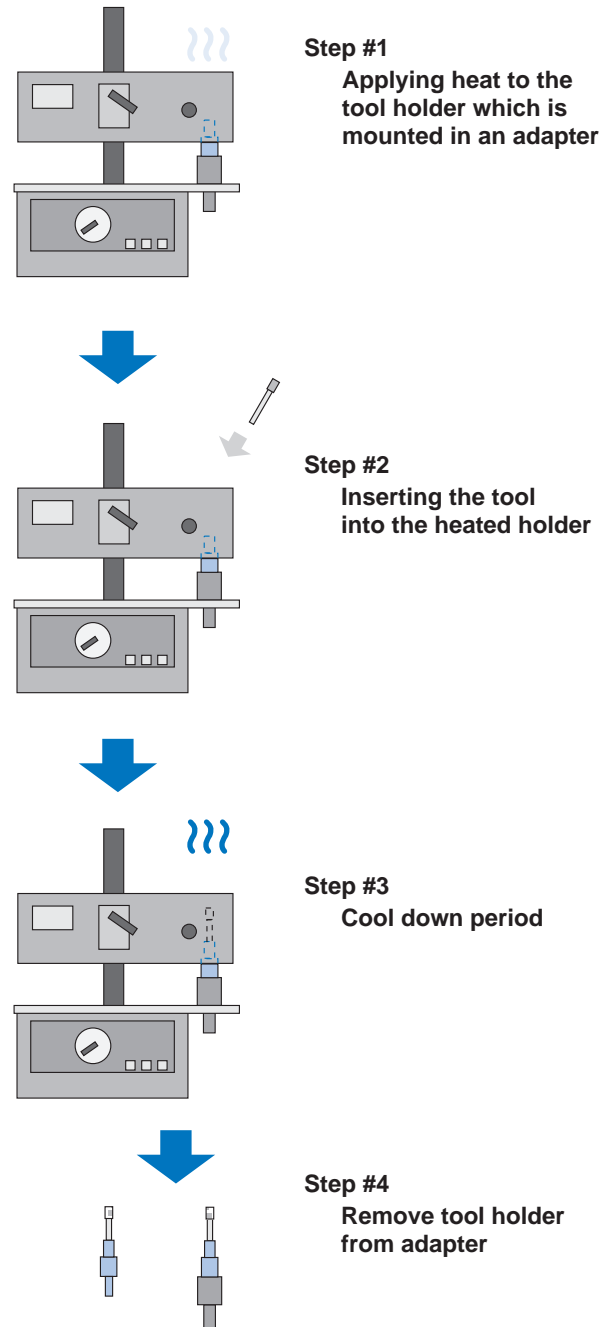

Shrink Fit Tool Holders

Tungsten carbide mounted abrasive points
Tungsten carbide milling cutters

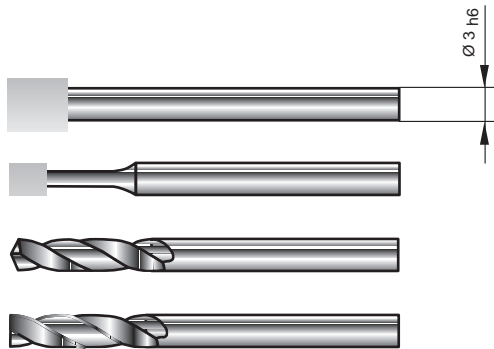

The use of tungsten carbide tools is economical due to the cylindrical form and rigid because of the high modulus of elasticity.

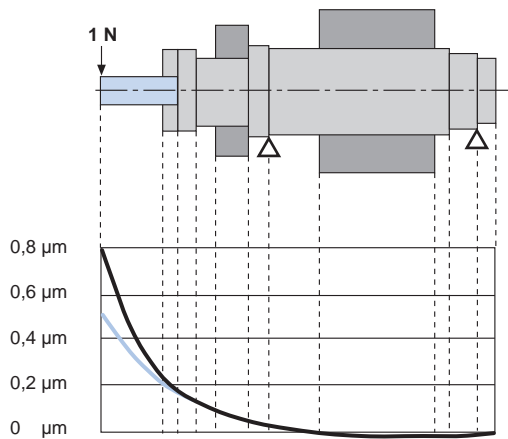

The diagram illustrates the calculated stiffness model for a typical spindle shaft with a mounted abrasive point show in *Blue*.

Using shrink fit mounted tungsten carbide tool shanks, and applying a radial load of 1 N at the end of the tool, the calculated deflection is 0.5 µm, if the tool were made of standard tool steel and mounted in a collet chuck the deflection would be 0.8 µm. Another advantage of use of carbide significantly lowers the natural frequency of the system.

Combining tungsten carbide tools with shrink fit style holders is a technically superior/low cost solution for attaining the critical attributes required in high speed machining.

Application restrictions

The proper operation of a spindle is determined by effects of tooling lengths, weights, and geometry. The positive qualities of the shrink fit holders and tungsten carbide tooling described in this section are not to be construed as declaration for all applications.

GMN is pleased to offer our analytical services to determine the proper selection for spindles and tooling.

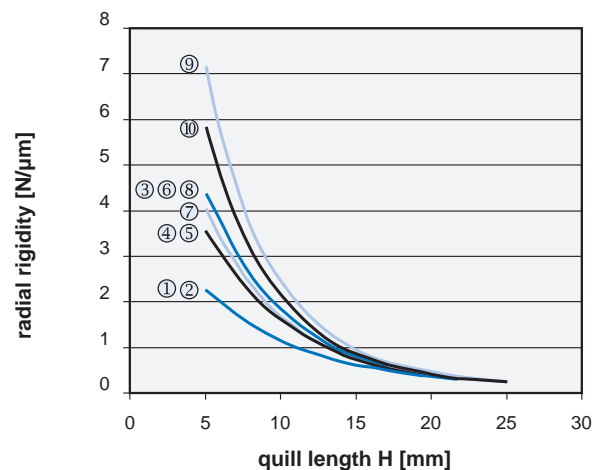
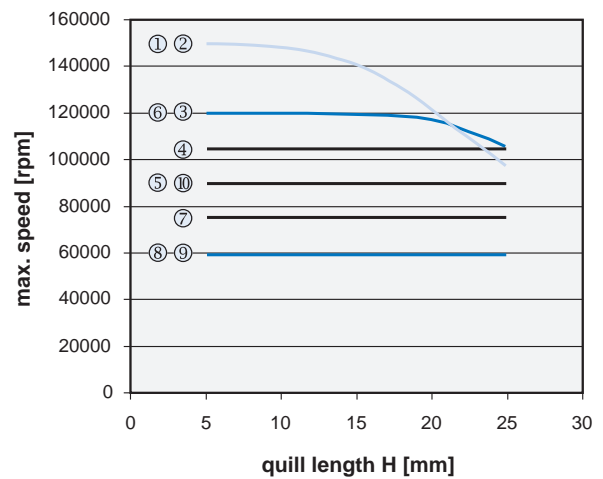

- | | |
|---------------------|---------------------|
| ① HS 80c-180000/0,4 | ② HS 80c-150000/0,5 |
| ③ HS 80c-120000/1,1 | ④ HSX 100-105000/2 |
| ⑤ HS 80c-90000/2 | ⑥ HSX 80-120000/1,1 |
| ⑦ HSX 100-75000/5 | ⑧ HSX 100-60000/5 |
| ⑨ HSX 120-60000/7 | ⑩ HSX 100-90000/3 |

Short taper interface

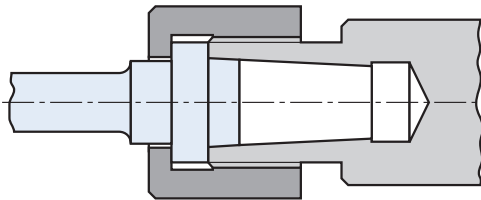

Direct quill interface

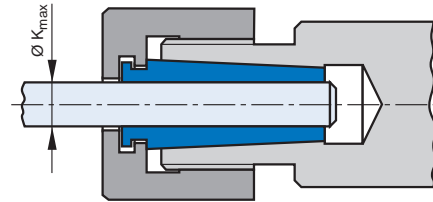

Collet clamping method

Quills and grinding wheel attachments (examples)

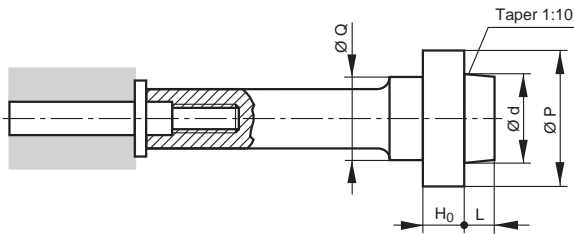

- Quill with threaded mounted wheel mandrel

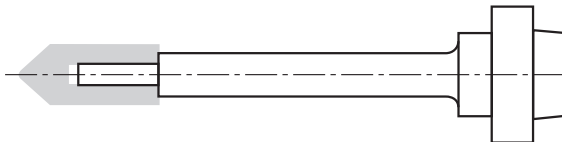

- Grinding quill, solid
- Material: steel or tungsten carbide
- Cemented or glued on wheel

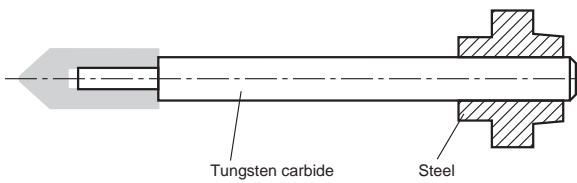

- Grinding quill (2) piece construction
- Tungsten carbide pin mated to steel pilot
- Cemented or glued on wheel

Designation	d [mm]	L [mm]	P [mm]	H ₀ [mm]	Q [mm]	K _{max} [mm]
T 7	7	3	10.4	2.8	7.95	4
T 9	9	3	13.6	2.9	11.3	6
T 12	11.9	5	18.6	4.4	16.85	8

"Hollow tapered shanks with flat contact surfaces" are standard per DIN 69893. The different "FORM'S" of a particular size are based on a similar shank size (d1) dimension.

The tool flange is dictated by the mode of tool change.

HSP/HV-P style spindles allow the use of tools with short hollow shanks, type "A" and "C". Form "C" was developed specially for manual tool changing systems. Form "A" is distinguished by the "V" groove provided for automatic tool changing systems.

Form "A" can also be used with the manual tool change system provided in the HSP/HV-P style spindles. This reduces the need for additional tool holders if automatic tool changing systems are already in place.

Tools according to Form B, D, E and F cannot be used in the HSP/HV-P style spindles, they are designed for different applications.

HSK Form C according to DIN 69 893

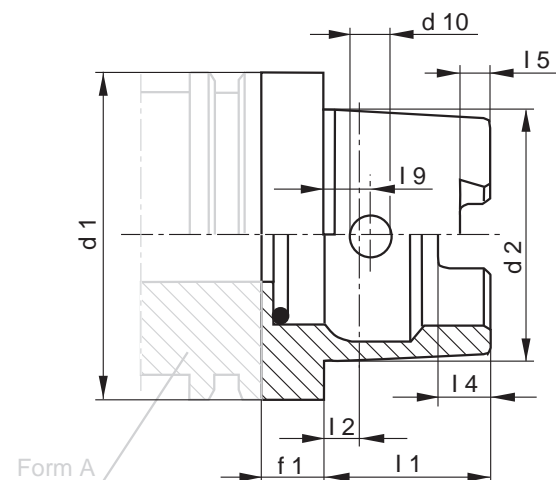
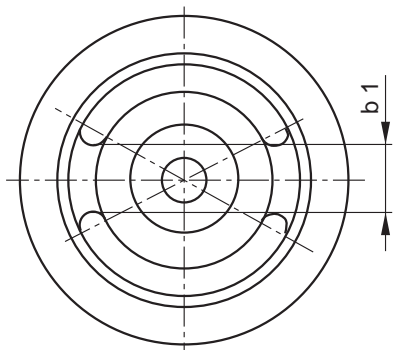

Nominal size = d1	Taper-Ø d2 [mm]	d10 [mm]	Taper length l1 [mm]	l2 [mm]	l4 [mm]	l5 [mm]	l9 [mm]	b1 [mm]	f1 [mm]
25 ¹⁾	19	3.5	13	2.5	4	2	4	6	8
32	24	4	16	3.2	5	3	5	7	10
40	30	4.6	20	4	6	3.5	6	8	10
50	38	6	25	5	7.5	4.5	7.5	10.5	12.5
63	48	7.5	32	6.3	10	6	9	12.5	12.5
80	60	8.5	40	8	12	8	12	16	16
100	75	12	50	10	15	10	15	20	16

1) During the development of this catalog style HSK 25 was not yet a DIN Standard.

Clamping System

Hollow taper shanks with flat contact surface

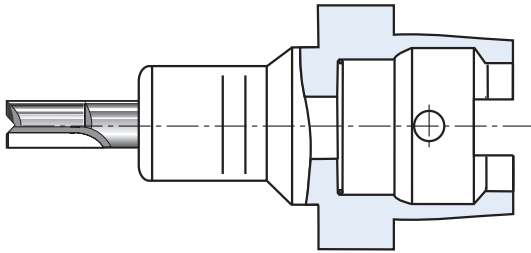

Driving slots

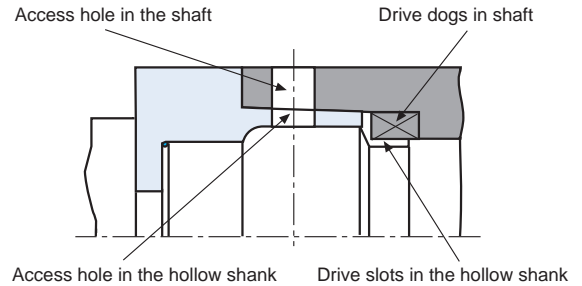

Advantages:

- > High static and dynamic rigidity
- > High tool change accuracy and repeatability
- > Low axial movement during speed variations
- > Increased pull-in force as speed raise
- > High torque transmission
- > Reduced hazard due to internal drive dogs

The frictional contact between the tool shank and shaft face provides excellent torque transmission. The internal drive dogs provide additional holding power to keep the access holes aligned in the shaft and tool when overloaded.

Manual actuating

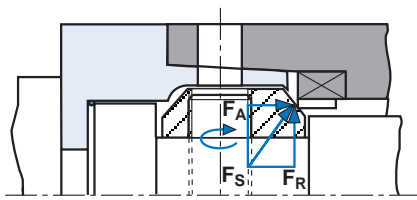

The claws of the gripper assembly are actuated outward, when the radially positioned differential threaded rods are actuated, and force component F_A axially into the tool holder, thus pulling the tool holder shank against the shaft face, and pressing the tapered portion of the shank to its elastic limits against the shaft's internal taper via component F_R .

Hollow shank and axial plane surface

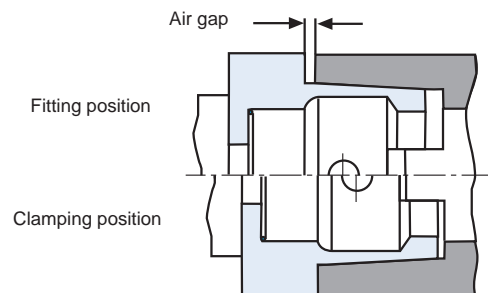

The manual system is designed so that during installation a gap exist between the shank face and the shaft.

The required rigidity is produced through the stress against the taper and axial surfaces generated by the force of the clamping system.

Tools

Shrink fitted tool shank

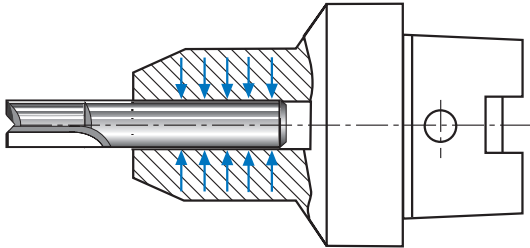

Shrink fitted type holders for cylindrical tool shanks are similar to monolithic holders:

- > high radial rigidity
- > high runout accuracy
- > high transferable torque
- > high repeatability during tool change

A preheater is required.

Hydraulic expansion chuck

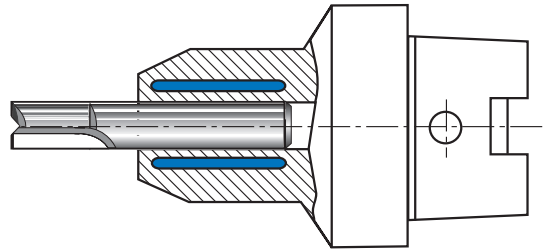

Hydraulic expansion chucks offer high runout accuracy. Tools can be replaced quickly. A device for exchange is not necessary. Reduction bushings allow smaller shank diameters to be clamped, this can effect the run out.

The oil cell across the tool shank leads to vibration damping and improves the surface quality.

Fine boring tool

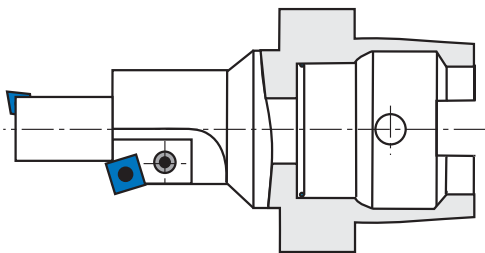

Reversible carbide tipped inserts **must** be positively locked or the strain caused by the centrifugal forces at high speeds, on the screws alone can lead to vibration and shearing. For safety reasons the permitted peripheral speed must be analyzed and maintained.

Asymmetry causes unbalance. To avoid inadmissible vibrations tools have to be balanced to an acceptable degree.

Collet chuck

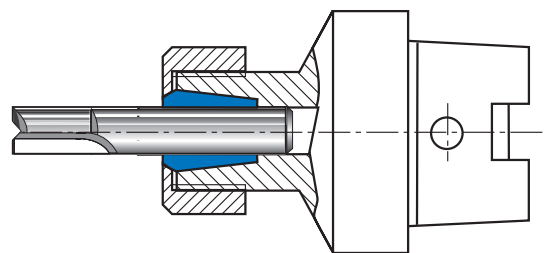

Collet chucks are an economical alternative for light duty machining at low speeds, with low accuracy requirements.

Special designs are required for high speed machining.

Collet chucks are readily available and require a minimal effort to change shank sizes.

Safe start due to pre-lubricating

The unit is designed for the optimised supply of lubricant to GMN spindles. The (6) lubricating points allow for the connection of one, two or three spindles. The pre-lubricating cycle guarantees a safe start during machine start-up. The separate monitoring of the oil level assures trouble free completion of the operation.

The supply lines can be laid so that they rise or drop. The line length has to be between 0.5...5 m.

The units

- > PRELUB MV 2 - 2 lubricating point connections
 - > PRELUB MV 4 - 4 lubricating point connections
 - > PRELUB MV 6 - 6 lubricating point connections
- are with integrated oil/air mixing distributor.

The oil/air mixing distributor for PRELUB style MV 0 has to be ordered separately. The mixing distributor can be mounted in up to max. 30 m away the unit.

Refer to the spindle operating instruction manual or test certificate for oil quality, cycle times and pressures.

Equipment

- > Air/filter regulator (5 µm) with air gauge
- > Interface with the machine tool control system to signal readiness for operation after checking
 - oil level
 - oil pressure and oil release pressure
 - air pressure
 - pre-lubricating cycle
- > Timer for matching cycle time to oil viscosity and spindle data
- > Lubricating point connections for PVC tubing, O.D 6 mm
- > Operating voltage 230 V, 50/60 Hz
Option 110 V, 50/60 Hz
- > Air supply G 1/2"
 $p_{min} = 6 \text{ bar}$, $p_{max} = 10 \text{ bar}$
- > Power supply and monitoring via connector
- > Installed in control cabinet
380 x 380 x 210 mm (W x H x D)
Enclosure IP 54
- > Colour: RAL 7032 (grey)
- > Fuse protection for 230 V: 1 A; 110 V: 2 A

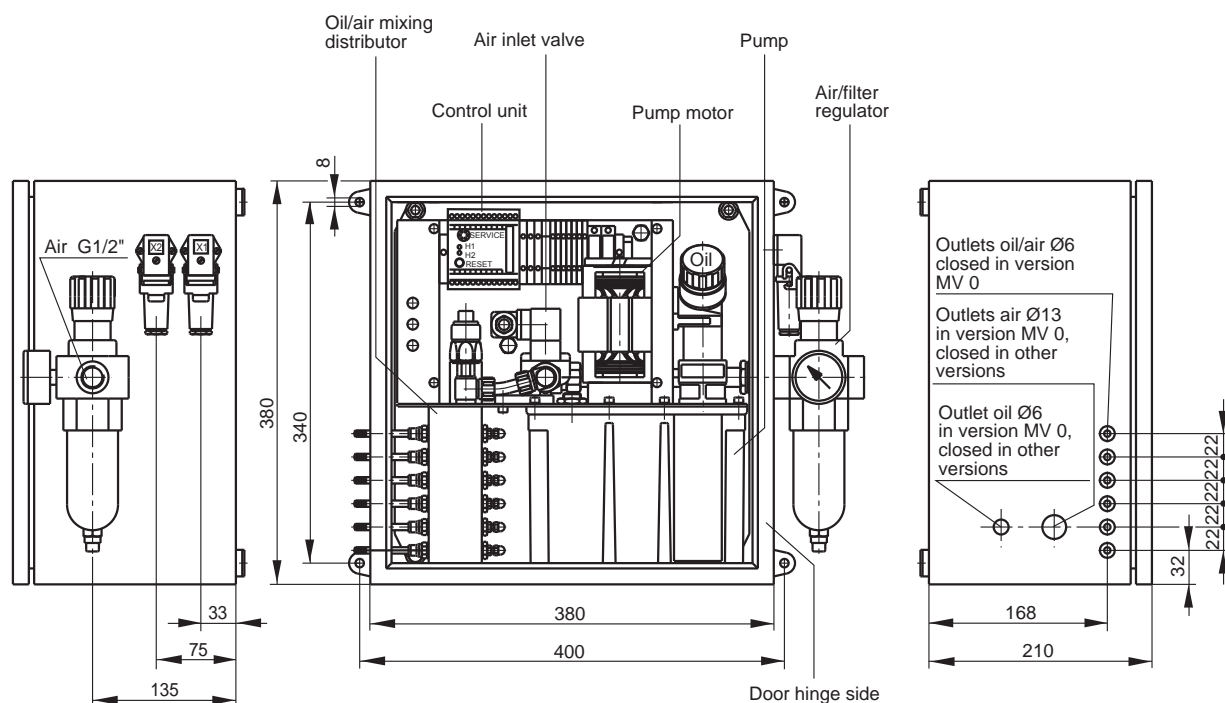

Oil/air Lubricator PRELUB

Oil/air mixing distributor (6 outlets)

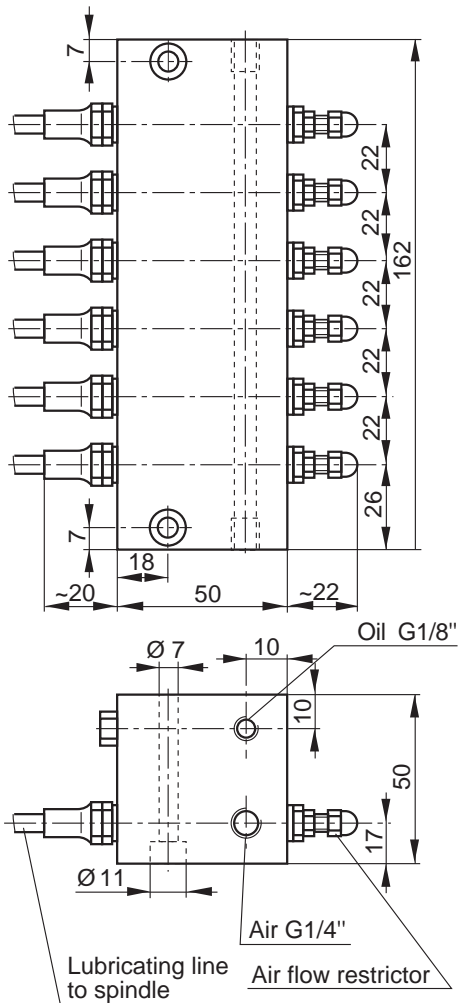
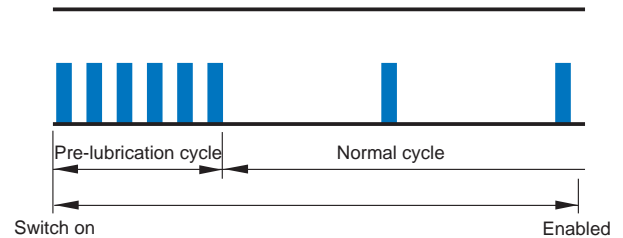

Diagram of pre-lubrication



- > Switch on the oil/air lubricator
- > Carrying out the pre-lubrication cycle before the enable signal to the spindle is given for operating:
 - several lubricating pulses within a short time (pre-lubrication cycle)
 - transition to the normal cycle, that means cycle time as during spindle operation
- > The spindle is enabled after the pre-lubrication cycle time is finished (depends on the length of the line)

Control of the air pressure

The reliability and reliability of operation of the oil/air lubricator PRELUB has been confirmed for many years in a lot of applications. Nevertheless manometric switches can be mounted additional in the lubricating lines on customer's requirements. The evaluation is made directly by the machine control.

Accessories

Required accessories for the installation and commissioning such as tubing, pressure gauge and filtered lubricating oil are available.

Maintenance

Compressed air and lubricating oil must be pre-filtered as describe in the operating instruction manual.

Replacement filter cartridges are available for both filter elements.

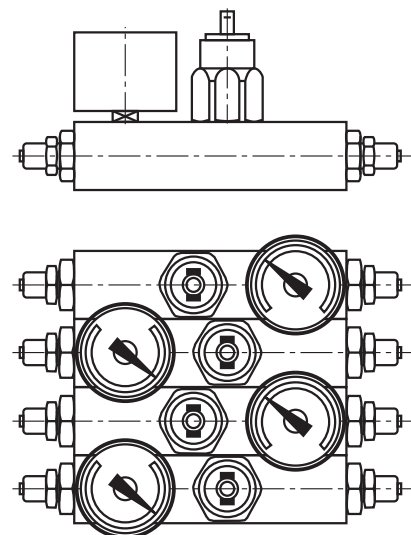

GMN high frequency spindles utilize the most powerful motors available for their size. The current draw through the windings causes extreme temperature rises, which are limited by the insulation.

In order to obtain peak performance the heat must be dissipated.

We can provide the proper size self contained units for removing the motor and bearing heat losses.

- > The units operate with FCKW free refrigerant R407c
- > Coolant temperature 20°C ... 25°C
- > Control hysteresis
 Style T: ± 2°K, Style F: ± 1°K
- > Option: for control of axial shaft growth temperature can be controlled to
 Style T: ± 1.2°K, Style F: ± 0.5°K
- > Acceptable ambient temperature + 42°C
- > Option: single supply units for multi spindle applications
- > Fluid level monitoring, flow switch and fault indicator for protecting spindles
- > Colour
 Style T: blue according to RAL 5019 ⁴⁾
 Style F: grey according to RAL 7032 ⁴⁾
- > A rust inhibitor must be added to the cooling solution



Style T



Style F

Type	Cooling capacity ²⁾ [kW]	for spindle power [kW]		Tank capacity [l]	Supply voltage ³⁾	Dimensions L x B x H [mm]
		S6-60%	S1			
K 0.9-T/2	0.9	6	4.5	18	1 x 230 V, 50 Hz	705 x 510 x 450
K 1.4-T/2	1.4	9.3	7	18	1 x 230 V, 50 Hz	705 x 510 x 450
K 2.5-T/2	2.5	16.6	12.5	18	1 x 230 V, 50 Hz	705 x 510 x 450
K 3.9-T/2	3.9	26	19.5	30	1 x 230 V, 50 Hz	755 x 600 x 500
K 5.3-T/2	5.3	35.3	26.5	30	1 x 230 V, 50 Hz	755 x 600 x 500
K 2.6-F ¹⁾	2.6	17.3	13	90	3 x 400 V, 50 Hz	715 x 715 x 1375
K 4.1-F ¹⁾	4.1	27.3	20.5	90	3 x 400 V, 50 Hz	715 x 715 x 1375
K 6.7-F ¹⁾	6.7	44.6	33.5	90	3 x 400 V, 50 Hz	715 x 715 x 1375

1) In the refrigerant circulation additional to high pressure monitoring low pressure monitoring.

2) At 37°C ambient temperature and 20°C water temperature.

The cooling capacity decreases at higher ambient temperatures.

3) Different voltages and frequencies on request.

4) Different RAL colours on request.

Chillers

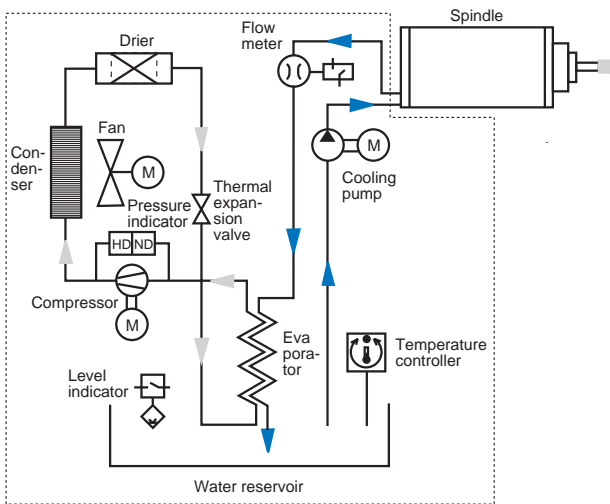

Coolant circulation:

- > The recirculating pump in the chiller moves coolant from the reservoir to the spindle back to the tank.
- > The coolant absorbs heat as it passes through the spindle.
- > The coolant returns to the chiller and passes through the evaporator/heat exchanger where heat is absorbed from the coolant into the refrigerant.
- > The "refrigerated" coolant then returns to the reservoir.

Refrigerant circulation:

- > Cool refrigerant gas is pumped out of the evaporator/heat exchanger by the compressor and compressed into a high temperature, high pressure gas and delivered to the condenser.
- > In the condenser the gas condenses into a liquid as it dissipates heat to the air being blown across the condenser fins.
- > The cooled, high-pressure liquid refrigerant then passes through the expansion valve to the low-pressure side of the evaporator. The refrigerant absorbs heat from the coolant passing through the evaporator as it changes from a liquid to a gas.

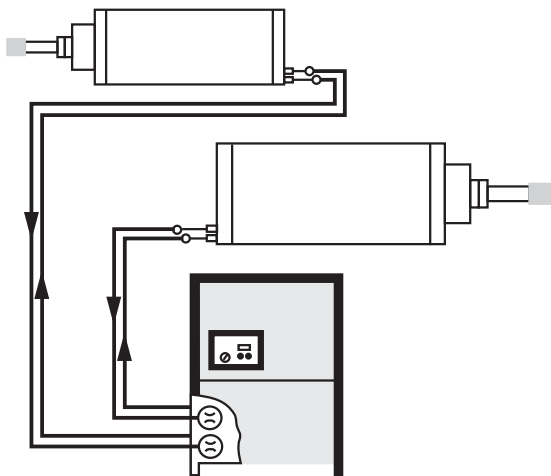

Parallel connection:

- > Multiple spindles operating from a single chiller unit.
- > Spindles of different sizes, cooling and flow requirements should be connected in parallel.
- > It is important to select the correct chiller with sufficient cooling and flow capacity for all the spindles being used.
- > Individual flow monitoring units are required for each cooling loop.

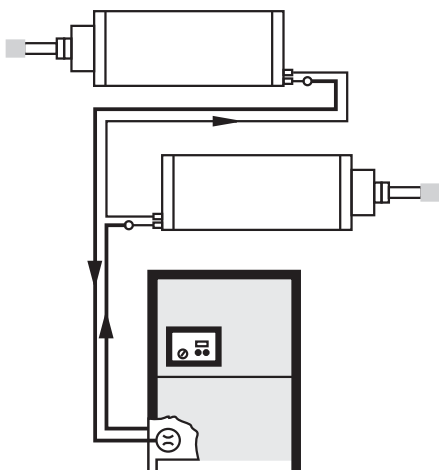

Series connection:

- > Multiple spindles operating from a single chiller unit.
- > Spindles of the same sizes, cooling and flow requirements should be connected in series.
- > Do not plump more than two (2) spindles in series.
- > A single flow monitoring unit is required for a series setup and mounted at the end of the run.

Please contact GMN for assistance in choosing the proper sized chiller unit.

Typical Applications

Grinding raceway in ball bearing
outer race, $v \approx 80$ m/s

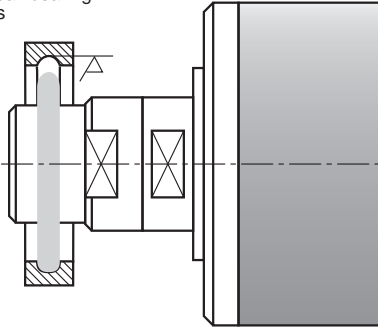

Grinding or **precision hard milling** ball raceway in
socket end of universal joint

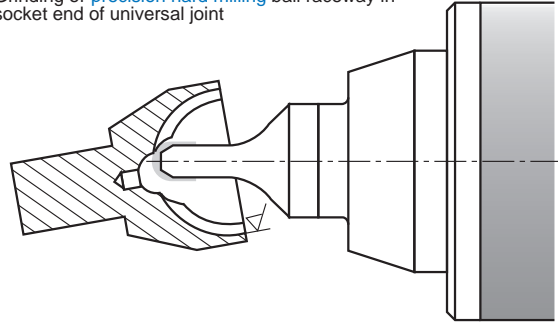

Grinding bore in ball bearing
inner race, $v \approx 80$ m/s

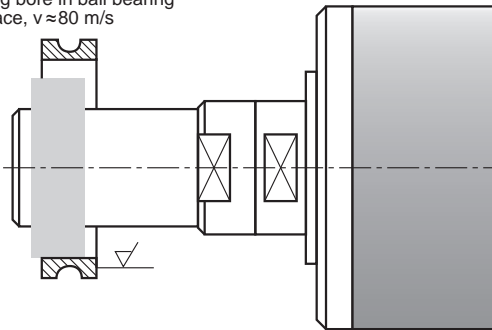

Grinding roller raceways in double-row
needle bearing, $v \approx 60$ m/s

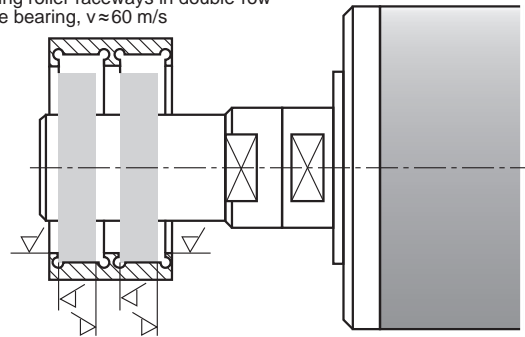

Grinding bore with
small internal taper, $v \approx 35$ m/s

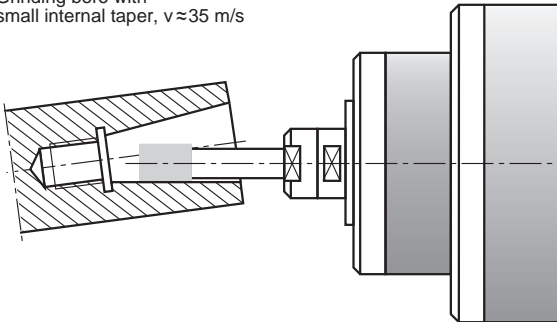

Grinding bore and bottom face
with coolant supply through shaft, $v \approx 60$ m/s
alternative through **precision hard milling**

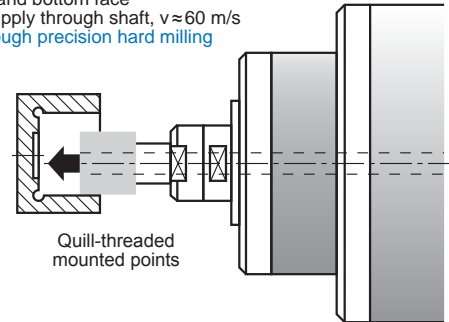

Grinding bore and conical seating
in fuel injector, $v \approx 35$ m/s

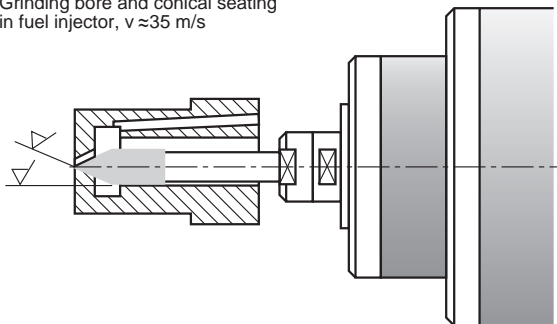

Grinding bore
in collet chuck, $v \approx 45$ m/s

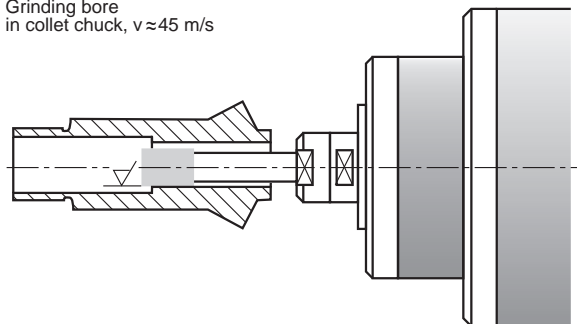

Standard values for precision milling

Material	Cutting material	Cutting speed v_c [m/min]	Feed rate f_z [mm]	Surface finish R_{zDIN} [μ m]
Cold work tool steel heat-treated, HRC 63	CBN	150...300	0.025...0.1	0.5...5
Hot work tool steel, HRC 45 tensile strength 800 N/mm ²	Cermet	120...160	0.1...0.2	0.5...2
Nodular graphite iron heat-treated, HRC 58	CBN	180...220	0.15...0.2	0.7...3.5
Turbine blades steel tensile strength 1000 N/mm ²	Tungsten carbide, coated	600	0.1	1.5...3
St 70 tensile strength 900 N/mm ²	Tungsten carbide, coated	400	0.3	1...2.5
Gray cast iron, alloyed	Tungsten carbide, coated	1200	0.15	2...3

Standard values for drilling into solid material

Material	Cutting material	Cutting speed v_c [m/min]	Feed rate f_z [mm]	Form error EKF [μ m]
Turbine blades steel tensile strength 1000 N/mm ²	Tungsten carbide, coated ¹⁾	70	0.08	5...16
Heat-treatable steel tensile strength 800 N/mm ²	Tungsten carbide, coated ¹⁾	200	0.06	6
Gray cast iron, alloyed tensile strength 260 N/mm ²	Tungsten carbide, coated ¹⁾	200	0.06	10...13

1) Coolant through tool.

Standard values for boring

Material	Cutting material	Cutting speed v_c [m/min]	Feed rate f [mm/U]	Form error EKF [μ m]
Turbine blades steel tensile strength 1000 N/mm ²	Cermet ¹⁾	200...220	0.05...0.125	1...3
Heat-treatable steel tensile strength 800 N/mm ²	Cermet ¹⁾	200	0.025...0.1	1...3
Gray cast iron, alloyed tensile strength 260 N/mm ²	Cermet ¹⁾	125...175	0.05...0.1	1...3

1) Initial condition rough-finished, with supported tool, with coolant.

Main source for the data:

"Hochpräzisionszerspanen mit geometrisch bestimmter Schneide, FQS-Schrift 96-03, Beuth-Verlag GmbH"

Turn-milling

Turn-milling describes a method of processing a rotating workpiece via a rotating tool with geometrical determined cuts, e.g. milling cutter.

Advantages

- > high cutting speed when operating next to the rotating axis of the workpieces
- > low forces of gravity while manufacturing unbalanced parts because of low rotational velocity of the workpiece
- > perfect chip breaking due to interrupted cut

Specific attributes for process

- > improved surface quality because of large differential relationship of speed between tool and workpiece
- > improved surface quality because of controlled overlapping of cut traces

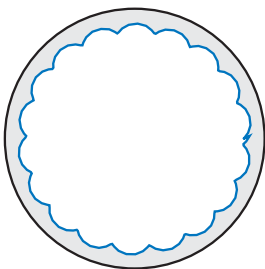

without overlapping of cut traces

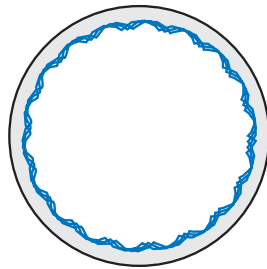

2 times overlapping of cut traces

Process variations

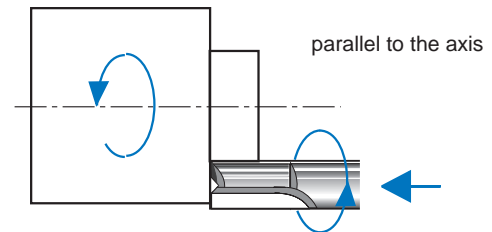
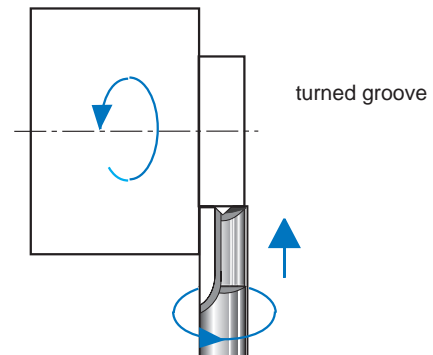
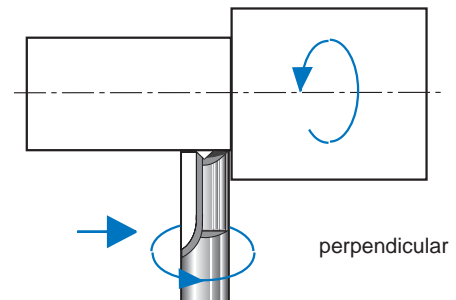

Standard values for turn-milling

Material	Cutting material	Cutting speed v_c [m/min]	Feed rate f_z [mm/U]	Depth of cut a_e [mm]
Ball and roller bearing steel, hardened, HRC 62	CBN ¹⁾	350...400	0.1...0.15	≥0.1
Heat-treatable steel HRC 52	P 40 ¹⁾	200...275		≥0.1
Austenitic steell X 5 CrNi 18 9	P 40 with TiN medium temperature-CVD-coating ²⁾	175		1...3

1) Cooling/lubricating: dry

2) Cooling/lubricating: oil mist

Flowchart for selecting the optimum spindle

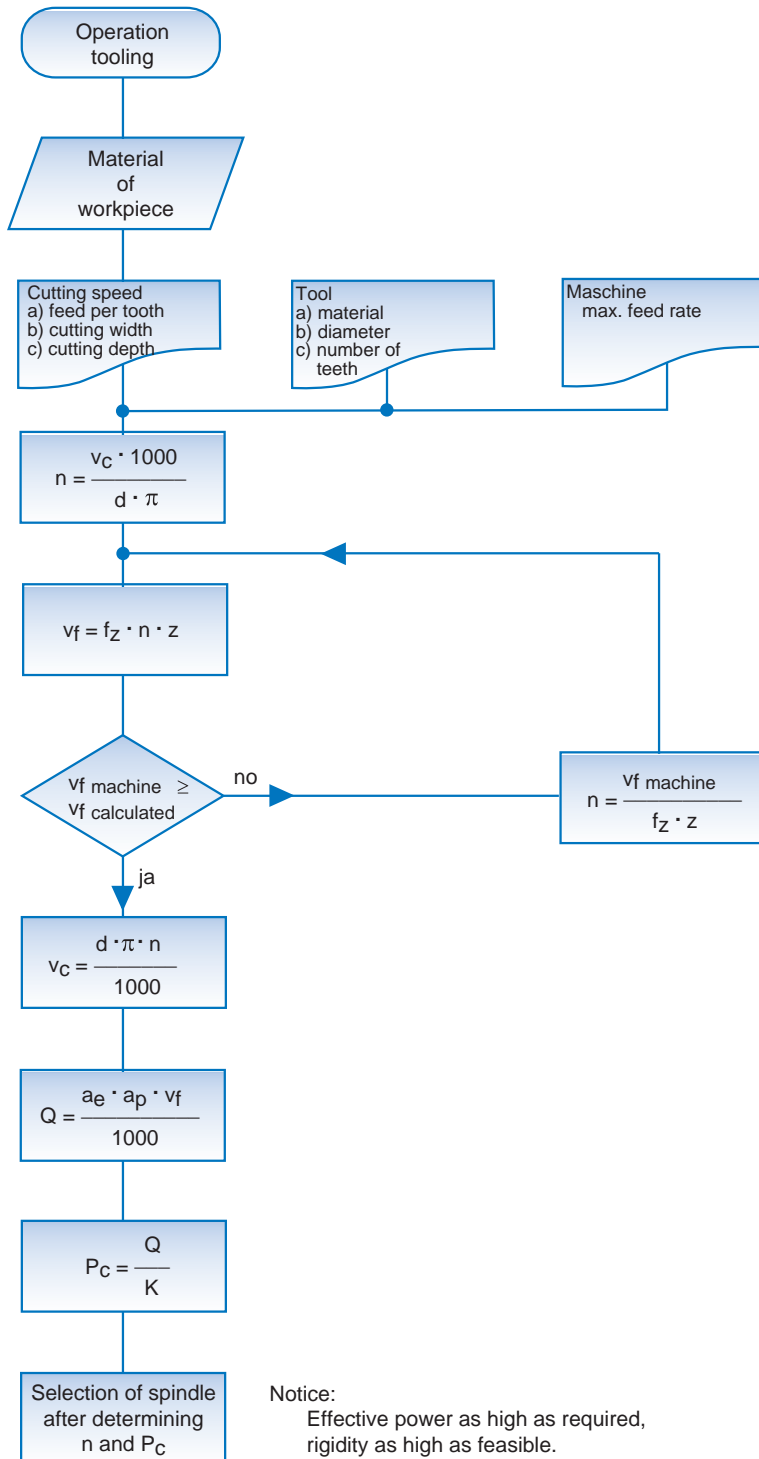

Notice:
Effective power as high as required,
rigidity as high as feasible.

Symbols and values

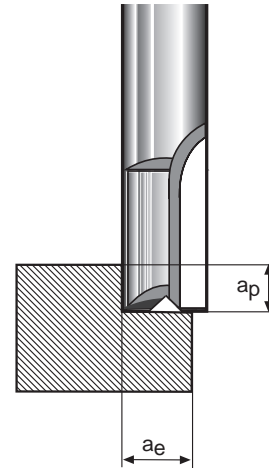

a_e [mm]	Cutting width
a_p [mm]	Cutting depth
d [mm]	Tool diameter
f_z [mm]	Feed rate per tooth
z	Number of teeth
n [1/min]	Spindle speed
v_f [mm/min]	Feed rate
v_c [m/min]	Cutting speed
P_C [kW]	Effective power
Q [cm ³ /min]	Volume of material
K [cm ³ /kW min]	Spec. material removal rate

Standard values for K

Structural steels	10..5
Alloy steels	5..8
Cast iron	15..30
Casting steel	10..15
Aluminium alloy	60..70

Workpiece Cooling

Dry machining

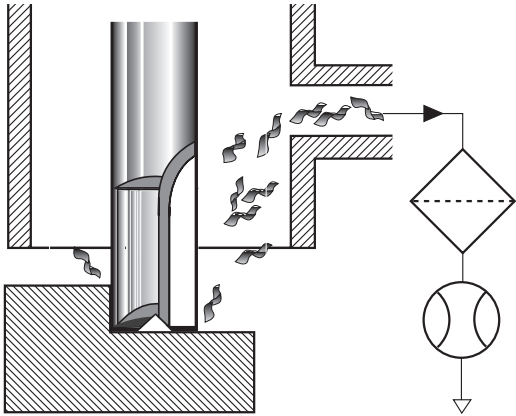

- Advantages:
- > no cost for coolant
 - > no swarf contamination
 - ⇒ low costs for disposal
 - > slight expenditure for sealing machine and spindle
 - > environmentally compatible

- Disadvantages:
- > lower tool life
 - > reduced rate of metal removal
 - > surface finish quality

Liquid cooling/lubrication

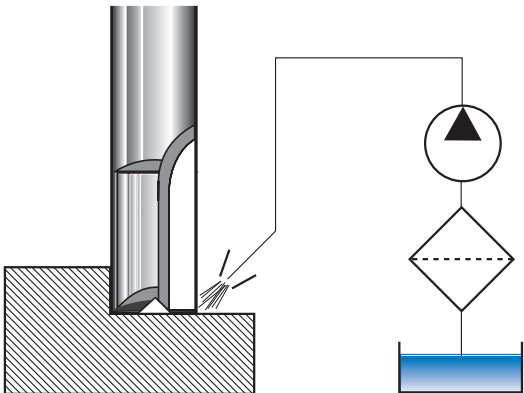

- Advantages:
- > higher surface finish quality
 - > size control
 - > long tool life
 - > large rate of metal removal

- Disadvantages:
- > costly machine sealing
 - > high costs for chip disposal and used coolant

Spray cooling/lubrication

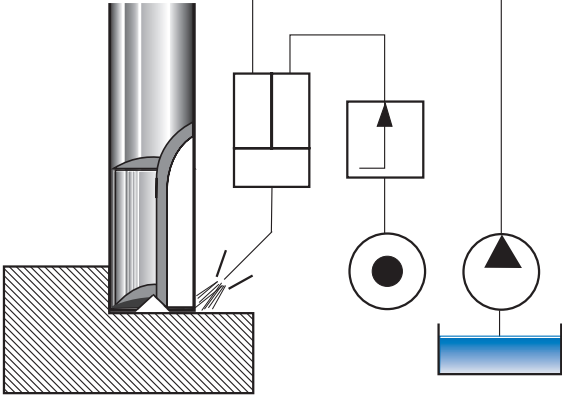

- Advantages versus dry machining:
- > improved tool life and surface finish quality
 - > increased rate of metal removal
 - > feasible surface protection of workpiece

- Disadvantages versus dry machining:
- > costly spindle sealing

- Disadvantages versus liquid cooling/lubrication:
- > more difficult chip removal

Quality Assurance

Test certificate

The record supplied with every GMN spindle contains actual data about axial and radial rigidity, vibration values, power and temperature. Other measurement conditions and limiting values differing from the GMN test standard can be accommodated.

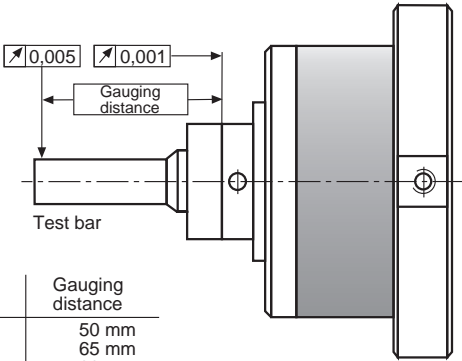

Size	Gauging distance
HSK 25	50 mm
HSK 32	65 mm
HSK 40	80 mm
HSK 50	100 mm
HSK 63	125 mm

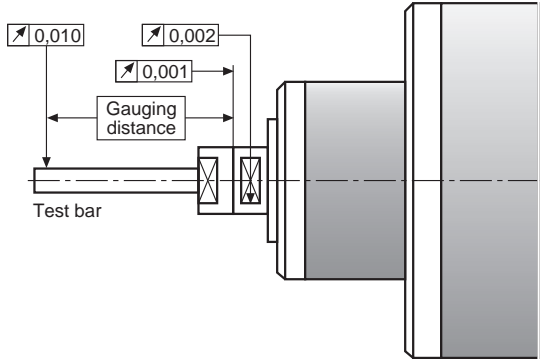

Gauging distance:
5 x face hole diameter, max. 100 mm

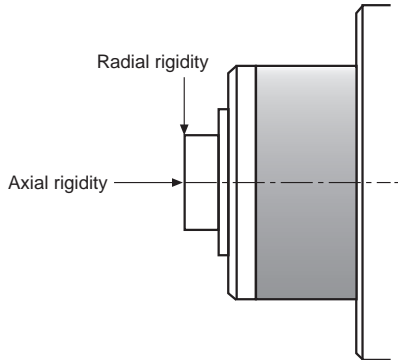

Operating instructions

Operating instructions are available in English and German. They are also obtainable in other languages on request.

Training

Courses with theoretical and practical content for using GMN spindles and fittings and carrying out repair work are offered.

Initial operation

Spindles and spindle systems can be commissioned by GMN technical personnel on request; outside Germany, this may be carried out by our authorised service companies. It is a prerequisite that the spindle is correctly installed using correct materials, fluids and initial start-up preparation.

Repair service

We recommend that the spindles are repaired by us or our authorized repair shops.

The GMN spindle repair service offers cost-effective, rapid and professional work. We also have the necessary special equipment, such as balancing instruments, vibration and rigidity measuring instruments and devices for assembly and dismantling.